

www.dos-p.com

# HERRAJES



# COCINAS Y ARMARIOS



C/ SEÚL, 1 POL. MARTINSA  
MADRID TEL. 916 970 814  
madrid@dos-p.com

C/ CAUDAL 51 POL. EL VISO  
MÁLAGA TEL. 952 331 419  
info@dos-p.com

C/ METALURGIA 43 POL. CALONGE  
SEVILLA TEL. 608 463 787  
sevilla@dos-p.com

# www.dos-p.com



Catálogo





# ÍNDICE

	PÁGINA:		PÁGINA:
<span style="color: red;">■</span> Bisagras y mecanismos de elevación	3	<span style="color: gold;">■</span> Soportes y escuadras	69
Bisagras Hettich Sensys	4-7	Soportes y baldas	70-71
Bisagras Hettich Intermat	8-9	Soportes y patas	72-73
Bisagras Teknoit con freno	10-11	Mesas y estructuras	74-75
Bisagras Teknoit sin freno	12-13	<span style="color: gray;">□</span> Iluminación y electricidad	77
Mecanismos de elevación	14-15	Iluminación	78-81
Aperturas escamoteables	16	Enchufes	82-87
Mecanismos de elevación	17	<span style="color: darkred;">■</span> Fregaderos y grifos	89
<span style="color: lightgreen;">■</span> Sistemas de cajones y guías	19	Fregaderos	90-92
Cajón Hettich Avantech You	20-21	Grifos	93
Cajón Hettich Arcitech	22-23	<span style="color: gold;">■</span> Herrajes y consumibles	95
Cajón Hettich Atira	25-26	Colgadores y tornillería	96-97
Cajón Tekno PRO	27	Consumibles y siliconas	98-99
Cajón Teknoit	28-29	<span style="color: brown;">■</span> Herrajes y accesorios de armarios	100
Sistemas de guías y correderas	30-31	Armarios Hettich	102-103
<span style="color: blue;">■</span> Accesorios cajones	33	Accesorios de armario	104-107
Organizadores cajón/cacerolero	34-37	Perfilería y herrajes de armario	108-109
Organizadores Hettich	38-39	Herrajes de armario	110-111
Organizadores de madera	40-41	<span style="color: teal;">■</span> Ayudas a la planificación	113
<span style="color: orange;">■</span> Alambres y cestos	43	Plantillas y Maquinaria	114-115
Protectores y rejillas	44	<span style="color: purple;">■</span> Tiradores	117
Escurreplatos y vasos	45	Tiradores modernos	118-161
Accesorios de alambre	46-50	Pomos	162-166
Cestos de ropa	51	Tiradores clásicos	167-181
Cubos de basura	52-55		
<span style="color: gray;">■</span> Accesorios, perfiles y patas	57		
Bisagras rincón	58		
Bastidores	58		
Marcos microondas	58		
Protectores	58-59		
Coperos, botelleros y colgadores	60		
Perfilería para cristal	61		
Perfil con goma	61		
Vitrinas	62		
Zócalos	63		
Patas	64		
Copetes y cantoneras encimera	65		
Persianas	66		
Salida de humo	67		



# BISAGRAS Y MECANISMOS DE ELEVACIÓN

	PÁGINA
Bisagras Hettich Sensys .....	4-7
Bisagras Hettich Intermat .....	8-9
Bisagras Teknoit con freno .....	10-11
Bisagras Teknoit sin freno .....	12-13
Mecanismos de elevación .....	14-15
Aperturas escamoteables .....	16
Mecanismos de elevación .....	17

## Bisagras Hettich Sensys con freno y clip



### Apertura 110° Solapada (normal)

Bisagra automática con montaje por clip y amortiguación integrada  
 Clasificación de la calidad según EN 15570, nivel 3  
 Para grosor de puerta 15 - 24 mm  
 Diámetro de cazoleta 35 mm  
 Profundidad de cazoleta 12,8 mm  
 Ajuste de solapadura + 2 mm / - 2 mm integrado  
 Ajuste de profundidad + 3 mm / - 2 mm integrado  
 Ajuste de altura a través del suplemento  
 Material brazo de bisagra: acero niquelado  
 Material cazoleta: acero niquelado  
 Distancia 45mm Taco 8 mm  
 Distancia 48 y 52 mm Taco 10 mm

\* Consultar otras medidas de taladro y acabados  
 \*\* Los tacos níquel son directos y obsidian expansivos.  
 Consultar otros tacos.



Normal

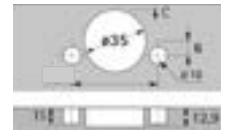

Dis. Taladro	Níquel	Obsidian
S/T 52 mm	80905F	809059091738
Taco 45 mm	80905FT45	*
Taco 48 mm	80905FT48	*
Taco 52 mm	80905FT52	809059091771



### Apertura 90° (Bisagra plana para mueble rincón)

Bisagra automática con montaje por clip y amortiguación integrada  
 Clasificación de la calidad según EN 15570, nivel 2  
 Para armarios de rincón  
 Para grosor de puerta 15 - 28 mm  
 Diámetro de cazoleta 35 mm  
 Profundidad de cazoleta 12,8 mm  
 Ajuste integrado para el resalte de puerta + 1 mm / - 2 mm  
 Ajuste integrado de fuga + 3 mm / - 2 mm  
 Ajuste de altura a través del suplemento  
 Material del brazo de bisagra: zamak niquelado  
 Material cazoleta: acero niquelado  
 Distancia 45mm Taco 8 mm

\* Consultar otras medidas de taladro y acabados  
 \*\* Los tacos níquel son directos y obsidian expansivos.  
 Consultar otros tacos.

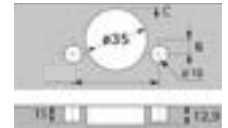

Taco	Níquel	Obsidian
S/T 52 mm	809059088021	809059091748
T. 45mm	809059088045	*
T. 48mm	809059088051	*
T. 52mm	809059088039	809059091780



### Apertura 110° Semi Solapada (acodada)

Bisagra Sensys 110°  
 Con amortiguación integrada, con automatismo de cierre (Sensys 8645i)  
 Clasificación de la calidad según EN 15570, nivel 3  
 Ángulo de apertura 110°  
 Para grosor de puerta 15 - 24 mm  
 Tipo de montaje Semisolapado  
 Profundidad de cazoleta 12,8 mm  
 Montaje montaje tirafondos  
 Ajuste de solapadura integrado +2 mm / -2 mm  
 Ajuste de profundidad integrado +3 mm / -2 mm  
 Ajuste de altura a través del suplemento  
 Acero niquelado

\* Consultar otras medidas de taladro y acabados  
 \*\* Los tacos níquel son directos y obsidian expansivos.  
 Consultar otros tacos.



Acodada

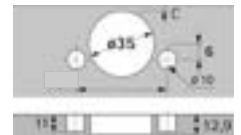

Taco	Níquel	Obsidian
S/T 52 mm	809059071206	809059091739
T. 45mm	809059071227	*
T. 48mm	809059071245	*
T. 52mm	809059071209	809059091772



### Apertura 110° Arremetido (superacodada)

Bisagra Sensys 110°  
 Con amortiguación integrada, con automatismo de cierre (Sensys 8645i)  
 Clasificación de la calidad según EN 15570, nivel 3  
 Ángulo de apertura 110°  
 Para grosor de puerta 15 - 24 mm  
 Tipo de montaje Arremetido  
 Profundidad de cazoleta 12,8 mm  
 Montaje montaje tirafondos  
 Ajuste de solapadura integrado +2 mm / -2 mm  
 Ajuste de profundidad integrado +3 mm / -2 mm  
 Ajuste de altura a través del suplemento  
 Acero niquelado  
 Distancia 45mm Taco 8 mm  
 Distancia 48 y 52 mm Taco 10 mm

\* Consultar otras medidas de taladro y acabados  
 \*\* Los tacos níquel son directos y obsidian expansivos.  
 Consultar otros tacos.



Super acodada



Taco	Níquel	Obsidian
S/T 52 mm	809059071207	809059091740
T. 45mm	809059071228	*
T. 48mm	809059073634	*
T. 52mm	80905SAFT52	809059091773

## Bisagras Hettich Sensys con freno y clip

### Apertura 165° Solapado



Bisagra automática con montaje por clip sin amortiguación integrada  
 Clasificación de la calidad según EN 15570, nivel 3  
 Para grosor de puerta 15 - 32 mm  
 Diámetro de cazoleta 35 mm  
 Profundidad de cazoleta 11,6 mm  
 Ajuste de solapadura + 2 mm / - 2 mm integrado  
 Ajuste de profundidad + 3 mm / - 2 mm integrado  
 Ajuste de altura a través del suplemento  
 Posibilidad de reducir el ángulo de apertura mediante accesorio opcional  
 Bisagra sin resalte  
 Material brazo de bisagra: acero niquelado  
 Material cazoleta: acero niquelado

\* Consultar otras medidas de taladro y acabados  
 \*\* Los tacos níquel son directos y obsidian expansivos. Consultar otros tacos.

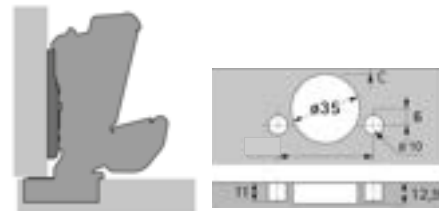

Taco	Níquel	Obsidian	Níquel SIN freno
S/T. 52 mm	80905F165	809059091767	809059099600
T. 45mm	809059099561	*	*
T. 48mm	809059099581	*	809059099641
T. 52mm	809059099541	809059091789	809059099601

### Ángulo interior 120° (W30)



Bisagra automática con montaje por clip sin amortiguación integrada  
 Clasificación de la calidad según EN 15570, nivel 3  
 Para armarios en diagonal, ángulo de armazón 120°  
 Para grosor de puerta 15 - 28 mm  
 Diámetro de cazoleta 35 mm  
 Profundidad de cazoleta 12,8 mm  
 Ajuste de solapadura + 2 mm / - 2 mm integrado  
 Ajuste de profundidad + 3 mm / - 2 mm integrado  
 Ajuste de altura a través del suplemento  
 Material del brazo de bisagra: zamak niquelado  
 Material cazoleta: acero niquelado

\* Consultar otras medidas de taladro y acabados  
 \*\* Los tacos níquel son directos y obsidian expansivos. Consultar otros tacos.

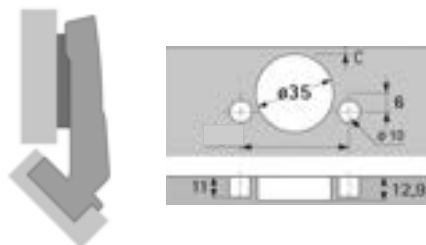

Taco	Níquel	Obsidian
S/T. 52 mm	80905F30	809059091745
T. 45mm	809059088040	*
T. 48mm	809059088046	*
T. 52mm	809059088034	809059091777

### Ángulo interior 135° (W45)



Bisagra automática con montaje por clip y amortiguación integrada  
 Clasificación de la calidad según EN 15570, nivel 3  
 Para armarios en diagonal, ángulo de armazón 135°  
 Para grosor de puerta 15 - 28 mm  
 Diámetro de cazoleta 35 mm  
 Profundidad de cazoleta 12,8 mm  
 Ajuste de solapadura + 2 mm / - 2 mm integrado  
 Ajuste de profundidad + 3 mm / - 2 mm integrado  
 Ajuste de altura a través del suplemento  
 Material del brazo de bisagra: zamak niquelado  
 Material cazoleta: acero niquelado

\* Consultar otras medidas de taladro y acabados

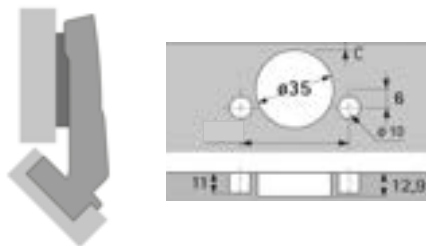

Taco	Níquel	Obsidian
S/T. 52 mm	80905F45	809059091747
T. 45mm	809059088043	*
T. 48mm	809059088049	*
T. 52mm	809059088037	809059091779

### Ángulo de apertura 95° para puertas gruesas ( Hasta 32 mm)



Bisagra automática con montaje por clip y amortiguación integrada  
 Clasificación de la calidad según EN 15570, nivel 2  
 Para grosor de puerta 15 - 32 mm  
 Diámetro de cazoleta 35 mm  
 Profundidad de cazoleta 12,8 mm  
 Ajuste de solapadura + 2 mm / - 2 mm integrado  
 Ajuste de profundidad + 3 mm / - 2 mm integrado  
 Ajuste de altura a través del suplemento  
 Material brazo de bisagra: acero niquelado  
 Material cazoleta: acero niquelado



\* Consultar otras medidas de taladro y acabados  
 \*\* Los tacos níquel son directos y obsidian expansivos. Consultar otros tacos.

Acabado	Normal	Acodada	Super acodada
Níquel S/T dist. 52	809059090260	809059091410	809059091420
Obsidian S/T dist. 52	809059091753	809059091755	809059091756
Níquel C/T dist. 52	809059090261	809059091411	809059091421
Obsidian C/T dist. 52	809059091754	809059091785	809059091757

## Apertura 110° Solapada para puertas delgadas 10 mm



Bisagra automática con montaje por clip y amortiguación integrada  
 Clasificación de la calidad según EN 15570, nivel 3  
 Para grosor de puerta 10 - 16 mm  
 Diámetro de cazoleta 35 mm  
 Profundidad de cazoleta 7,8 mm  
 Ajuste de solapadura + 2 mm / - 2 mm integrado  
 Ajuste de profundidad + 3 mm / - 2 mm integrado  
 Ajuste de altura a través del suplemento  
 Material brazo de bisagra: acero niquelado  
 Material cazoleta: acero niquelado

\* Consultar otras medidas de taladro y acabados  
 \*\* Los tacos niquel son directos y obsidian expansivos.  
 Consultar otros tacos.



Taco	Niquel	Obsidian
S/T 52mm	809059094270	809059091761
T. 52mm	809059094271	809059091793

## Bisagras Hettich sin freno con clip

### Intermat con cazoleta Sensys para puertas plegables esquinero angulo de apertura 50° / 65°



Bisagra automática con montaje por clip  
 Clasificación de la calidad según EN 15570, nivel 2  
 Diámetro de cazoleta 35 mm  
 Profundidad de cazoleta 12,8 mm  
 Ajuste diagonal + 9,5 mm / - 9,5 mm  
 Ajuste de solapadura integrado, véase dibujo  
 Ajuste de altura integrado, véase esbozo  
 Ajuste de altura a través del suplemento  
 Material del brazo de bisagra: zamak niquelado  
 Material cazoleta: acero niquelado

\* Consultar otras medidas de taladro y acabados

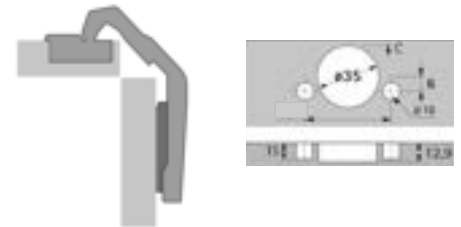

Dis. Taladro	Niquel
T. 52mm	809059090110
T. 48mm	809059090118

### Apertura 110° solapado (normal) SIN cierre automático (SIN MUELLE)



Bisagra con montaje por clip sin cierre automático  
 Por ejemplo para aplicaciones Push to open  
 Clasificación de la calidad según EN 15570, nivel 3  
 Para grosor de puerta 15 - 24 mm  
 Diámetro de cazoleta 35 mm  
 Profundidad de cazoleta 12,8 mm  
 Ajuste de solapadura + 2 mm / - 2 mm integrado  
 Ajuste de profundidad + 3 mm / - 2 mm integrado  
 Ajuste de altura a través del suplemento  
 Material brazo de bisagra: acero niquelado  
 Material cazoleta: acero niquelado

\* Consultar otras medidas de taladro y acabados



Dis. Taladro	Niquel
S/T 52mm	80905SM

### Apertura 110° Solapado sin amortiguación integrada (SIN FRENO)



Bisagra automática con montaje por clip sin amortiguación integrada  
 Clasificación de la calidad según EN 15570, nivel 3  
 Para grosor de puerta 15 - 24 mm  
 Diámetro de cazoleta 35 mm  
 Profundidad de cazoleta 12,8 mm  
 Ajuste de solapadura + 2 mm / - 2 mm integrado  
 Ajuste de profundidad + 3 mm / - 2 mm integrado  
 Ajuste de altura a través del suplemento  
 Material brazo de bisagra: acero niquelado  
 Material cazoleta: acero niquelado

\* Consultar otras medidas de taladro y acabados



Dis. Taladro	Niquel
S/T 52mm	809059071259



## BASES Y ACCESORIOS BISAGRAS SENSYS



Base avión , D = 0 y 3.0 mm, Ø 2,5, Distancia de hilera de taladros LR: 37, Ajuste de altura directo

Suplemento de avión mit Ajuste de altura

Para Sensys e Internat  
 Clasificación de calidad EN 15570,  
 Nivel 3 taladros 37 x 32 mm  
 Montaje con tornillos (Ø 2,5 mm)  
 Distancia 0.0 mm  
 Regulación + 2 mm / - 2 mm  
 Acero niquelado  
 \* Tornillo euro.

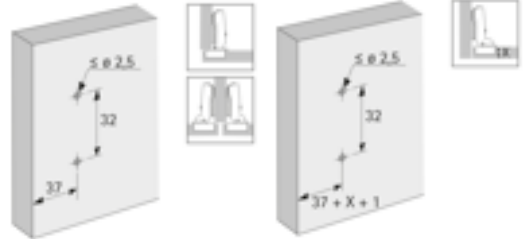

BASES AVION	Niquel		Obsidian	
	Tornillo Premontado	Taco 5 mm	Tornillo Premontado	Taco 5 mm
H=3 (16 mm)	80905S8099C	80905BET5	809059091805 *	809059091813
H=0 (19 mm)	80905B9071670 *	80905B19	809059091803 *	809091811

### Tapas para bisagras

Aplicable para bisagra con cazoleta en diseño Sensys  
 Aplicable para todas las variantes de fijaciones excepto para tornillos fijos y premontados.  
 Tornillos para madera  
 Acero niquelado

\* Consultar personalización y cantidades mínimas

Tapas	Niquel	Obsidian
Brazo	809069088250	80906NG
Cazoleta	80907	80907NG
<b>Plástico Antracita</b>		
Brazo 165°	809059099871	



Tapa Cazoleta



Tapa Brazo

### adaptador angular para base avión desde 5° hasta 20°

Aplicable para bisagra con cazoleta en diseño Sensys  
 Aplicable para todas las variantes de fijaciones excepto para tornillos fijos y premontados.  
 Tornillos para madera  
 Acero niquelado

\* Requiere Base chapa sin excéntrica



Base chapa sin excéntrica H=3 costado 16	
Base chapa	80905B9071577
Angulo	Niquel
5°	80905S5
10°	80905S10
15°	80905S15
20°	80905S20

### Amortiguación de apertura para bisagra 165°



Aplicable con bisagra de gran ángulo de apertura Sensys 8657i  
 Plástico antracita

Freno de apertura 165°	Plastico
Amortiguación apertura	809059100037

### Limitador de ángulo de apertura



Para reducir el ángulo de apertura de las puertas en armarios con componentes contiguos

Angulo	Plastico
Limitador de 110° a 85°	809059072540
Limitador de 95° a 85°	809059072541

### Limitador de ángulo apertura para Sensys 165°



Para reducir el ángulo de apertura de las puertas en armarios con componentes contiguos

Limitador bisagras 165°	Plastico
Limitador a 105° o 120°	809059090756
Limitador a 90° a 135°	809059090864

## Bisagras Intermat Hettich sin freno con clip

### Apertura 110° Solapada



Bisagra Intermat 110°  
 Con cierre automático (Intermat 9943)  
 Clasificación de la calidad según EN 15570, nivel 3  
 Ángulo de apertura 110°  
 Para grosor de puerta 15 - 25 mm  
 Tipo de montaje Solapado  
 Profundidad de cazoleta 11.6 mm  
 Montaje Montaje directo  
 Ajuste de solapadura integrado +2 mm / -2 mm  
 Ajuste de profundidad integrado +2.5 mm / -1.5 mm  
 Ajuste de altura a través del suplemento  
 Acero niquelado

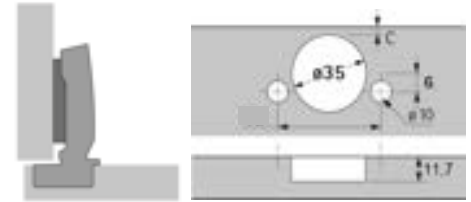

Dis. Taladro	Niquel
S/T 52mm	809051029518
Taco 45 mm	8090511029522
Taco 48 mm	809051085010
Taco 52 mm	80905

### Intermat W90 bisagra angular (bisagra plana o de mueble rincón)



Bisagra angular Intermat W90  
 Con cierre automático (Intermat 9936 W90)  
 Clasificación de la calidad según EN 15570, nivel 2  
 Ángulo de apertura 95°  
 Para grosor de puerta 14 - 28 mm  
 Tipo de montaje Solapado  
 Profundidad de cazoleta 10.5 mm  
 Montaje Montaje directo  
 Ajuste integrado para el resalte de puerta +2 mm / -2 mm  
 Ajuste de fuga integrado +2 mm / -2 mm  
 Ajuste de altura a través del suplemento  
 Acero / zamak niquelado

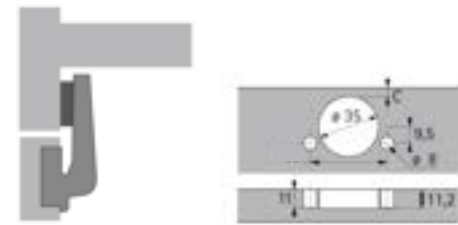

Dis. Taladro	Solapado	Arremetido
S/T 52mm	809059044844	8090577708
Taco 45 mm	809059043753	80905177710
Taco 48 mm	809059044818	809059044815
Taco 52 mm	809059044845	8090577709

### Apertura -30°



Bisagra angular Intermat W-30  
 Con cierre automático (Intermat 9944 W-30)  
 Clasificación de la calidad según EN 15570, nivel 2  
 Ángulo de apertura 125°  
 Para grosor de puerta 15 - 28 mm  
 Tipo de montaje Solapado  
 Esquema de taladros TH 52 x 5,5 mm  
 Profundidad de cazoleta 12.7 mm  
 Montaje montaje tirafondos  
 Ajuste de solapadura integrado +2 mm / -2 mm  
 Ajuste de profundidad integrado +2 mm / -2 mm  
 Ajuste de altura a través del suplemento  
 Acero / zamak niquelado

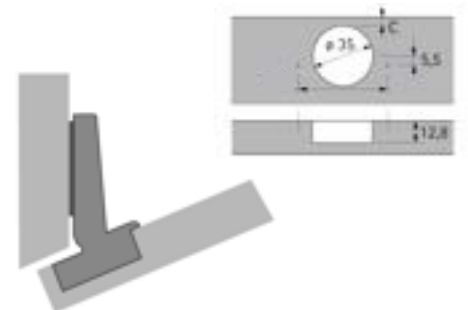

Dis. Taladro	Niquel
S/T 52mm	80905-30

### Apertura -45°



Bisagra angular Intermat W-45  
 Con cierre automático (Intermat 9944 W-45)  
 Clasificación de la calidad según EN 15570, nivel 2  
 Ángulo de apertura 125°  
 Para grosor de puerta 15 - 28 mm  
 Tipo de montaje Solapado  
 Esquema de taladros TH 52 x 5,5 mm  
 Profundidad de cazoleta 12.7 mm  
 Montaje montaje tirafondos  
 Ajuste de solapadura integrado +2 mm / -2 mm  
 Ajuste de profundidad integrado +2 mm / -2 mm  
 Ajuste de altura a través del suplemento  
 Acero / zamak niquelado



Dis. Taladro	Niquel
S/T 52mm	80905-45

## Bisagras Hettich especiales

### puertas de grandes espesores grosor de puerta hasta 43 mm



Intermat bisagra para puertas de grandes espesores.  
 Grosor de puerta hasta 43 mm  
 Con cierre automático (Intermat 9935)  
 Clasificación de la calidad según EN 15570, nivel 2  
 Ángulo de apertura 95 °  
 Para grosor de puerta 26 - 43 mm  
 Esquema de taladros TH 52 x 5,5 mm  
 Profundidad de cazoleta 13.7 mm  
 Montaje montaje tirafondos  
 Ajuste de solapadura integrado +2 mm / -2 mm  
 Ajuste de profundidad integrado +2.5 mm / -1.5 mm  
 Ajuste de altura a través del suplemento  
 Zamak niquelado



Acabado	Solapado	Semi-arremetido	Arremetido
Niquel S/T dist. 52	809059155241	809059155242	809059155243

### Bisagra especial Optimat Plus 4 FM



Aplicable para todas las anchuras de marco  
 Clasificación de la calidad según EN 15570, nivel 1  
 Para grosores de puerta a partir de 13 mm  
 Diámetro de cazoleta 35 mm  
 Profundidad de cazoleta 11 mm  
 Con cierre automático  
 Solapadura de puerta mínima de 37 mm (brazo de bisagra a ras con el canto del armazón)  
 Distancia de cazoleta 2,5 mm  
 Ajuste de solapadura + 1,5 mm / - 1,5 mm  
 Ajuste de altura + 2 mm / - 2 mm  
 Acero niquelado

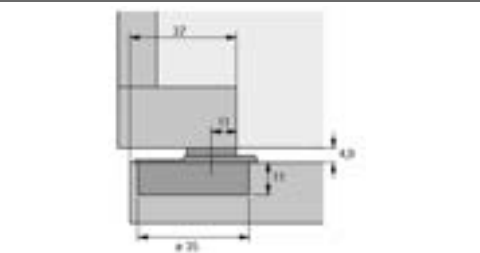

Dis. Taladro	Niquel
Sin taco	809059072548

### Bisagra puerta de frigorífico ET 582



Bisagra especial con resalte reducido para construcciones para frigoríficos  
 Diámetro de cazoleta 35 mm  
 Profundidad de cazoleta 12,8 mm  
 Con muelle  
 Incluido suplemento y placa distanciadora (calce = 3 mm) para solapaduras de 13 a 18 mm  
 Ajuste de solapadura + 1 mm / - 1 mm integrado  
 Ajuste de profundidad + 3 mm / - 3 mm integrado  
 Material brazo de bisagra: acero niquelado  
 Material cazoleta de bisagra: zamak niquelado  
 Material de la placa distanciadora de plástico blanco  
 Suplemento con placa distanciadora = Calce 3 mm  
 Suplemento sin placa distanciadora = calce 0 mm

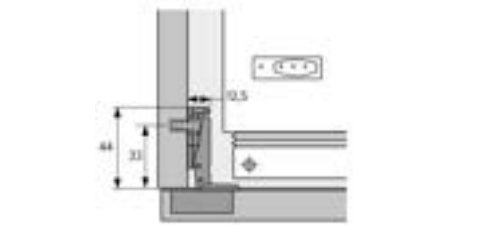

Dis. Taladro	Niquel
Sin taco	8090572134

### Push to open Silent, montaje tirafondos

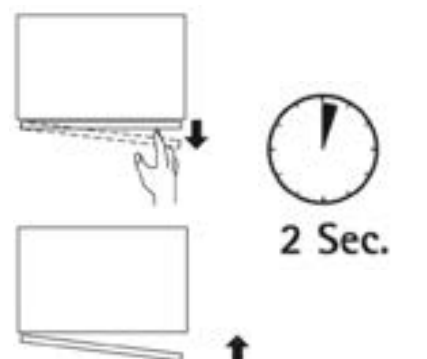

Para usar con bisagras con freno  
 Todo tipo de puertas solapadas y arremetidas  
 Rango de ajuste of + 4 / - 2 mm  
 Movimiento de apertura 1.4 mm  
 Distancia de aperturaa 45 mm  
 Incluye 4 AA batteries  
 Material: plástico

Push a pilas	Plástico
Antracita	90H9239087
Gris	90H9239099
Blanco	90H9239088

### Easys200 para frigoríficos, apertura automatizada



Apertura electrónica para frigoríficos automatizada.  
 Clasificación de calidad EN 15570, Nivel 3  
 Instalación en el perímetro del frigorífico.

Push eléctrico	Referencia
Easy type C	90H9210848

## Bisagras con freno clip (dos pasos, con regulación)

Modelo	Forma	Formula	Diametro	Dis. Taladro	Taco	Ref.
110° C=0		$H=12+K-(D)$	$\Phi 35\text{mm}$			
		<ul style="list-style-type: none"> <li>- Angulo de apertura: 110°</li> <li>- Profundidad cazoleta bisagra: 11.5mm</li> <li>- Diametro cazoleta bisagra: 35mm</li> <li>- Rango de grosor de puerta: 16-26mm</li> <li>- Distancias de taladro en la puerta (K): 3-6mm</li> </ul>				
				48 mm	Sin taco	80305RF
				48 mm	M10 taco	80305RFT48
				52 mm	M10 taco	80305RFT52
				45 mm	M8 taco	80305RFT45
110° Acodada C=9		$H=3+K-(D)$	$\Phi 35\text{mm}$			
		<ul style="list-style-type: none"> <li>- Angulo de apertura: 110°</li> <li>- Profundidad cazoleta bisagra: 11.5mm</li> <li>- Diametro cazoleta bisagra: 35mm</li> <li>- Rango de grosor de puerta: 16-26mm</li> <li>- Distancias de taladro en la puerta (K): 3-6mm</li> </ul>				
				48 mm	Sin taco	80305RAF
110° Super Acodada C=18		$H=6+K+(A)$	$\Phi 35\text{mm}$			
		<ul style="list-style-type: none"> <li>- Angulo de apertura: 110°</li> <li>- Profundidad cazoleta bisagra: 11.5mm</li> <li>- Diametro cazoleta bisagra: 35mm</li> <li>- Rango de grosor de puerta: 16-26mm</li> <li>- Distancias de taladro en la puerta (K): 3-6mm</li> </ul>				
				48 mm	Sin taco	80305RSAF
110° Vitrinas C=0		$H=-2 +V -(D)$	$\Phi 35\text{mm}$			
		<ul style="list-style-type: none"> <li>- Angulo de apertura: 110°</li> <li>- Profundidad de taladro marco de aluminio: 28mm</li> <li>- Rango de amplitud marco de aluminio: 19-23mm</li> </ul>				
				28 mm	Sin taco	80305RVF
90° Rincón			$\Phi 35\text{mm}$			
		<p>Rango de ajuste de L: -0.6 a +3.4</p> <p>Rango de ajuste de D: -40 a +2.0</p>				
				48 mm	Sin taco	80305R90F
				45 mm	M8 taco	80305R90FT45
155° C=0		$H=11+K-(D)$	$\Phi 35\text{mm}$			
		<ul style="list-style-type: none"> <li>- Angulo de apertura: 155°</li> <li>- Profundidad cazoleta bisagra: 11.5mm</li> <li>- Diametro cazoleta bisagra: 35mm</li> <li>- Rango de grosor de puerta: 16-24mm</li> <li>- Distancias de taladro en la puerta (K): 3-6mm</li> </ul>				
				48 mm	Sin taco	80305R165F
				45 mm	M8 taco	80305R165FT45

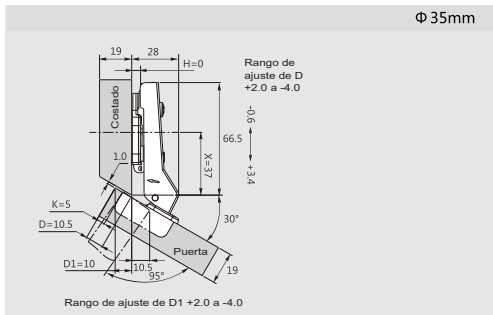

Dist. Tal	Taco	Ref.
48 mm	Sin taco	80305R30F
45 mm	M8 taco	80305R30FT45

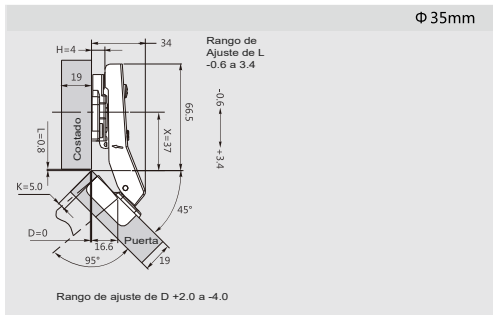

Dist. Tal	Taco	Ref.
48 mm	Sin taco	80305R45F
45 mm	M8 taco	80305R45FT45

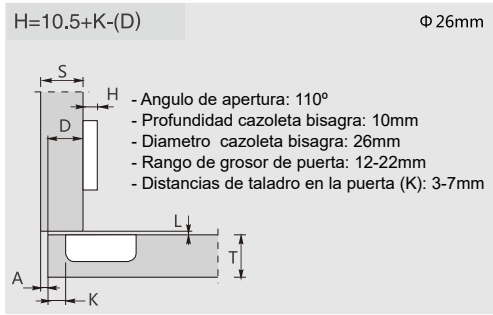

Dist. Taladro	Taco	Ref.
48 mm	Sin taco	80305R26F

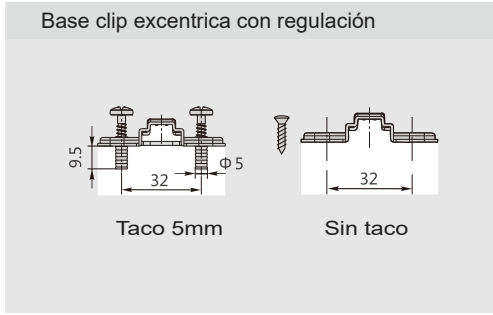
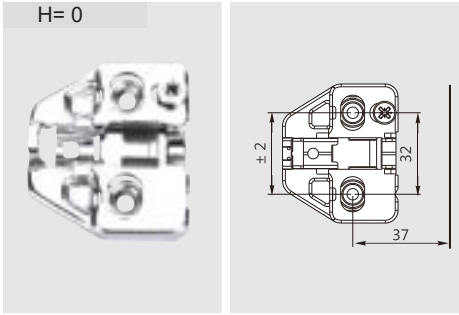

Altura	Taco	Ref.
H = 0	Sin taco	80305BFE
H = 0	Taco 5 mm	80305BFET5

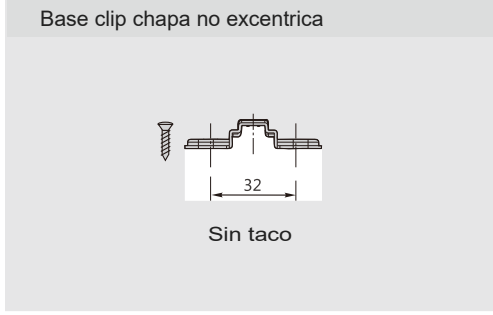
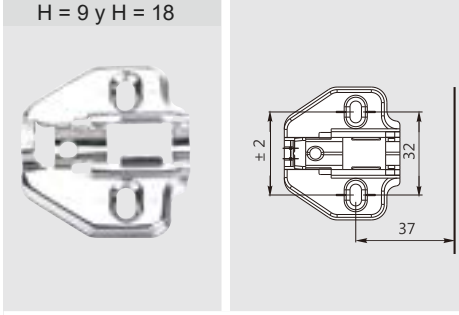

Altura	Sin taco
H=9 Acodada	80305B9
H=18 Super Acodada	80305B18

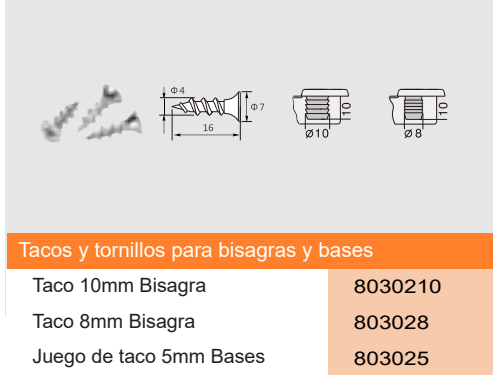

## EXPULSOR EMBUTIDO/SUPERFICIE CON REGULACIÓN



\* Cilindro para embutir. Base opcional para superficie.  
 \*\* Punta de silicona  
 \*\*\* Punta metálica con imán

K-PUSH	Corto	Largo
Normal	90244 ***	90244L ***
Fuerte		90244LFI **

## EXPULSOR SUPERFICIE CON REGULACIÓN



Expulsor superficie para puertas con punta de metálica

Expulsor con base punta metálica
90243

## EXPULSORES SUPERFICIE CON REGULACIÓN



Expulsor superficie para cajón con punta de silicona

Expulsor fuerte con base
90250

## SISTEMA DE PUSH Y FRENO PARA PUERTAS

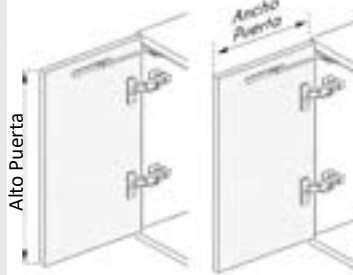

Alto mm	Ancho mm	Peso Kg	Ref.
700	600	7.5	90260L
2200	600	20	90260M
2800	600	25	90260H

Bisagras Tekno it clip (dos pasos, con regulación)

110° C=0	H=14+K-(D) $\Phi$ 35mm		Dis. Taladro	Taco	Ref.
		<ul style="list-style-type: none"> <li>- Angulo de apertura: 110°</li> <li>- Profundidad cazoleta bisagra: 11.3mm</li> <li>- Diametro cazoleta bisagra: 35mm</li> <li>- Rango de grosor de puerta: 14-24mm</li> <li>- Distancias de taladro en la puerta (K): 3-7mm</li> </ul>	48 mm	Sin taco	80305R
			48 mm	M10 taco	80305RT
			52 mm	M10 taco	80305RT52
			45 mm	M8 taco	80305RT45
110° Acodada C=9	H=5+K-(D) $\Phi$ 35mm		Dis. Taladro	Taco	Ref.
		<ul style="list-style-type: none"> <li>- Angulo de apertura: 110°</li> <li>- Profundidad cazoleta bisagra: 11.3mm</li> <li>- Diametro cazoleta bisagra: 35mm</li> <li>- Rango de grosor de puerta: 14-24mm</li> <li>- Distancias de taladro en la puerta (K): 3-7mm</li> </ul>	48 mm	Sin taco	80305RA
110° Super Acodada C=18	H=-4+K+(A) $\Phi$ 35mm		Dis. Taladro	Taco	Ref.
		<ul style="list-style-type: none"> <li>- Angulo de apertura: 110°</li> <li>- Profundidad cazoleta bisagra: 11.3mm</li> <li>- Diametro cazoleta bisagra: 35mm</li> <li>- Rango de grosor de puerta: 14-24mm</li> <li>- Distancias de taladro en la puerta (K): 3-7mm</li> </ul>	48 mm	Sin taco	80305RSA
110° C=0	H=-2 +V -(D) $\Phi$ 35mm		Dis. Taladro	Taco	Ref.
		<ul style="list-style-type: none"> <li>- Angulo de apertura: 110°</li> <li>- Profundidad de taladro marco de aluminio: 28mm</li> <li>- Rango de amplitud marco de aluminio: 19-23mm</li> </ul>	28 mm	Sin taco	80305RV

Bisagras Tekno it clip (dos pasos, con regulación)

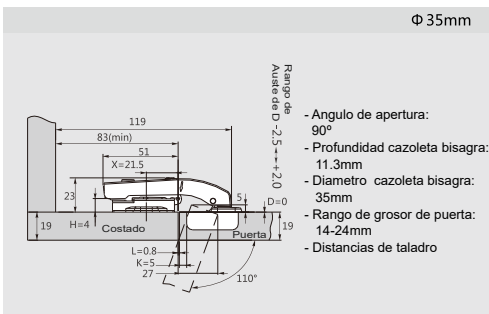

Dis. Taladro	Taco	Ref.
48 mm	Sin taco	80305R90
48 mm	M10 taco	80305R90T

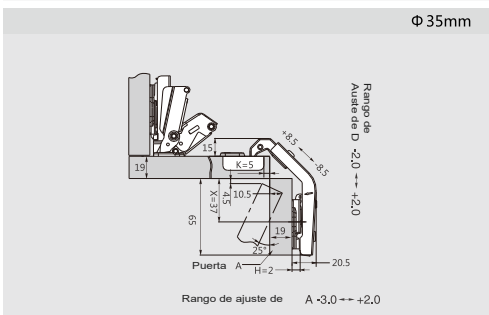

Dis. Taladro	Taco	Ref.
48 mm	Sin taco	80305RDP

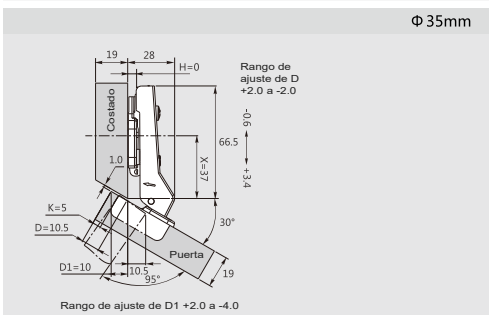

Dis. Taladro	Taco	Ref.
48 mm	M10 taco	80305R30

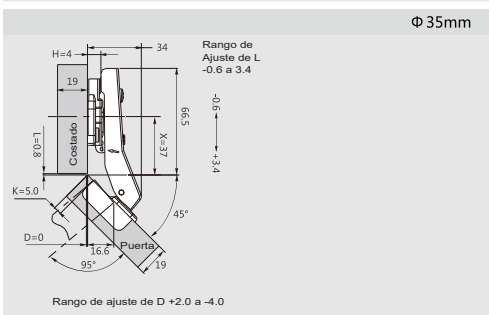

Dis. Taladro	Taco	Ref.
48 mm	M10 taco	80305R45T

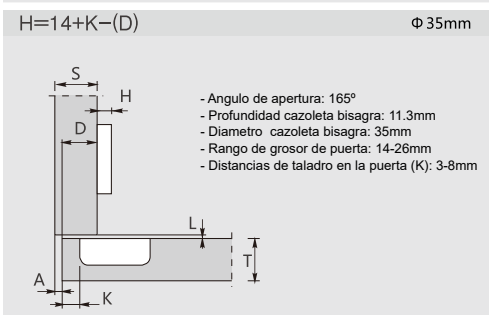

Dis. Taladro	Taco	Ref.
48 mm	Sin taco	80305R180
48 mm	M10 taco	80305R180T

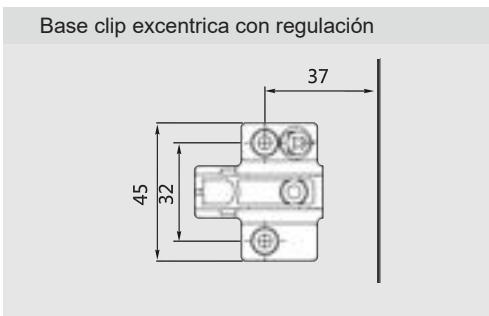

Altura	Taco	Ref.
H = 0	Sin taco	80305BE
H = 0	Taco 5 mm	80305BET5

# MECANISMO DE ELEVACIÓN

## FREE SPACE Mecanismo apertura horizontal



Modelo	PULL GRIS	PUSH GRIS
Tipo B	MEKFSBG	MEKFSBPSG
Tipo C	MEKFSCG	MEKFSCPSG
Tipo D	MEKFSDG	MEKFSDPSG
Tipo E	MEKFSEG	MEKFSEPSG
Tipo F	MEKFSFG	MEKFSFPSG
Adaptador Vitrina	MEKFSFAL	

Peso Puerta en Kg					
Altura	Tipo B	Tipo C	Tipo D	Tipo E	Tipo F
350	1,5 - 2,8	2,4 - 4,6	4,1 - 6,5	5,9 - 9,5	8,6 - 12,3
400	1,2 - 2,4	2,1 - 4,0	3,6 - 5,6	5,2 - 8,3	7,6 - 10,7
450	1,0 - 2,1	1,9 - 3,5	3,2 - 5,0	4,6 - 7,3	6,7 - 9,5
500	0,9 - 1,9	1,7 - 3,2	2,9 - 4,5	4,1 - 6,6	6,0 - 8,6
550	0,8 - 1,7	1,5 - 2,9	2,6 - 4,1	3,7 - 6,0	5,5 - 7,8
600	0,8 - 1,6	1,4 - 2,7	2,4 - 3,7	3,4 - 5,5	5,0 - 7,1

## FREE FLAP Mecanismo de apertura horizontal

FREEFLAP	REF.
Mini A	MHMA
Mini B	MHMB
Mini C	MHMC
Forte D	MHFD
Forte E	MHFE
Forte F	MHFF
Forte G	MHFG

Apertura horizontal sin bisagras con freno y regulación.

\* Los set incluyen jgo. mecanismo, tapas y fijación

\*\* Consultar otras medidas y pesos



Peso Puerta en Kg							
Altura	Mini A	Mini B	Mini C	Forte D	Forte E	Forte F	Forte G
300	1,1 - 3,1	2,4 - 5,1	4,4 - 9,6				
350	0,9 - 2,6	2,0 - 4,2	3,7 - 8,1	5,2 - 11,0	6,7 - 14,3	10,1 - 21,4	13,5 - 27,3
400	0,8 - 2,1	1,7 - 3,6	3,2 - 7,0	4,7 - 9,6	5,9 - 12,4	8,9 - 18,6	11,8 - 23,3
450	0,6 - 1,7	1,4 - 3,2	2,7 - 6,1	4,1 - 8,4	5,2 - 10,9	7,8 - 16,3	10,4 - 20,5
500				3,7 - 7,5	4,7 - 9,7	7,0 - 14,6	9,2 - 18,3
600				3,0 - 6,2	3,8 - 8,0	5,7 - 12,0	7,6 - 15,0

## FREE FOLD Mecanismo doble puerta



FREE FOLD	PESOS	Ref.
H 650/730 mm	3,9/7,9 KG	MDP6573
H 650/730 mm	9,5/18,7 KG	MDP657395187
H 770/840 mm	4,9/9,8 KG	MDP7784
H 840/910 mm	7,3/14,6 KG	MDP8491
Juego de tapas		MDPTK
Bisagras intermedia por unidad		80805BI

\* Consultar para otras medidas o pesos.

Altura de puerta				
580-650	650-730	710-790	770-840	840-910
2,2 - 4,4 kg	1,9 - 4,0 kg	3,5 - 7,2 kg	3,2 - 6,7 kg	4,5 - 9,0 kg
4,3 - 8,8 kg	3,9 - 7,9 kg	5,2 - 10,3 kg	4,9 - 9,8 kg	7,3 - 14,6 kg
6,0 - 12,2 kg	5,8 - 11,6 kg	8,7 - 17,2 kg	8,0 - 15,5 kg	10,0 - 20 kg
10,6 - 20,9 kg	9,5 - 18,7 kg		12,5 - 20,9 kg	



## FREE SWING Mecanismo de apertura oblicua



Apertura horizontal oblicua. Sin bisagras, con freno y regulación.

\* Las medidas de la puerta son el máximo aproximado. Consultar para medidas concretas.

FREE SWING	Ref.	PESOS
H-50/67	MOK5067	5/10KG
Juego de tapas	MOKT	
BARRA 1200mm	MRKB	

## FREE SLIDE Mecanismo de apertura recta

Apertura vertical sin bisagras con freno y regulación.

\* Las medidas de la puerta son el máximo aproximado. Consultar para medidas concretas.

FREE SLIDE	Ref.	PESOS
H-38/50	MRK3850	3,4/6,7KG
H-43/60	MRK4360	5/9,7 KG
Juego de tapas	MRKT	
Barra 1200mm	MRKB	



## Tekno it Mecanismo apertura horizontal



Apertura horizontal sin bisagras con freno y regulación.

\* Las medidas de la puerta son el máximo aproximado.

Consultar para otras medidas y acabados.

\*\* Los set incluyen juego. mecanismo, tapas antracita y fijación

TEKNO it	Ref.
LIGHT "L"	MHML02A
MEDIUM "M"	MHMM02A
HIGH "H"	MHGH02A
EXTRA HIGH "XH"	90E1213523

Ancho Alto	400 mm	450 mm	500 mm	600 mm	700 mm	800 mm	900 mm	1000 mm	1200 mm	1500 mm	1800 mm
350	LIGHT	LIGHT	LIGHT	LIGHT	MEDIUM	MEDIUM	MEDIUM	MEDIUM	HIGH	HIGH	EXTRA HIGH
400	LIGHT	MEDIUM	MEDIUM	MEDIUM	MEDIUM	MEDIUM	HIGH	HIGH	HIGH	EXTRA HIGH	EXTRA HIGH
450	MEDIUM	MEDIUM	MEDIUM	MEDIUM	HIGH	HIGH	HIGH	HIGH	EXTRA HIGH	EXTRA HIGH	EXTRA HIGH
500	MEDIUM	MEDIUM	MEDIUM	HIGH	HIGH	HIGH	HIGH	EXTRA HIGH	EXTRA HIGH	EXTRA HIGH	EXTRA HIGH
600	HIGH	HIGH	HIGH	EXTRA HIGH	EXTRA HIGH	EXTRA HIGH	EXTRA HIGH	EXTRA HIGH	EXTRA HIGH	EXTRA HIGH	EXTRA HIGH

## Tekno it Mecanismo apertura vertical (microondas)



TEKNO it	Ref.	ALTO PUERTA
Con freno. Puertas de 600 a 900 de ancho	90MPVPF	320 - 450mm
Sin freno. Puertas de 800 de ancho	90MPVP	320 - 450mm

# SISTEMAS DE APERTURA OCULTOS

## SISTEMA DE PUERTAS OCULTAS ESCAMOTEABLES



Acciones retorno de puerta

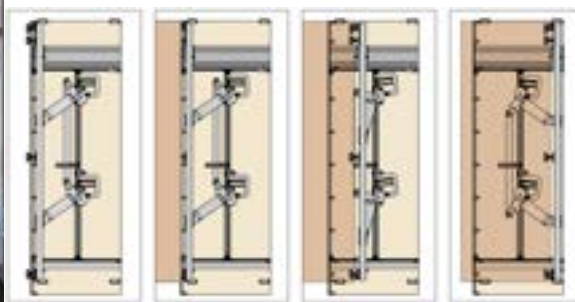

Profundidad	CONEXIÓN LEVAS – CARRO										KIT MECANISMO		Bisagras	Peso Max
	400 -500		501 – 600		601 – 700		701 – 800		801 – 900		Derecha	Izquierda		
Altura Puerta	Min	Max	Min	Max	Min	Max	Min	Max	Min	Max	YE55BAD1900NN	YE55BAS1900NN	3 X	18 Kg
	1576	1726	1698	1787	1820	1909	2032	2304	2154	2365	YE55BAD2500NN	YE55BAS2500NN	4 X	24 Kg
	2122	2530	2183	2530	2244	2530	2305	2530	2366	2530	YE55BAD2500NN	YE55BAS2500NN	5 X	30 Kg
Conexión levas	YE55KIT0101	YE55KIT0102	YE55KIT0103	YE55KIT0104	YE55KIT0105									

## GUÍAS ESCAMOTEABLES HETTICH

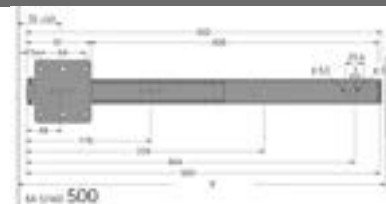

FONDO	GUIAS 14 KG
300 mm	90HK574030
350 mm	90HK574035
400 mm	90H41373
450 mm	90HK574045
500 mm	90H41375
550 mm	90HK574055
600 mm	90HK574060

- Para puertas de madera, con un peso máximo de 14 kg.
- Altura de puerta, hasta 1.800 mm.
- Ancho de puerta, 300 – 700 mm.
- Grosor de puerta máximo, 22,5 ó 32 mm.
- Con protección contra deslizamiento por inercia.

## PISTONES Y SISTEMAS DE APERTURA

### PISTÓN COMPACT (FRICCIONADO)



Regulación de apertura mediante fricción  
\* Consultar otras medidas

Medida	Fuerza newtons	Ref.
164 mm	60N (4 Kg)	9024060N164F
244 mm	60N (4 Kg)	9024060N244F
244 mm	90N (7Kg)	9024090N244F
355 mm	90N (7 Kg)	9024090N355F
Fijaciones		
Aluminio	Casco	Puerta
90240EAL	90240E	90240FP

### PISTÓN KRABY



Regulación de cierre y alineamiento de puertas

Medida	Fuerza newtons	Ref.
244 mm	100N (8 Kg)	90241100244R
164 mm	80N (6 Kg)	9024180244R
Fijaciones		
Aluminio	Casco	Puerta
90240EAL	90240FC	90240FP

### COMPAS REVERSIBLE CON RETENIDA



Ref.
90HJR

### PISTÓN SLIM Ø 12mm



Medida	Fuerza newtons	Ref.
244 mm	100N (8 Kg)	90247100244
244 mm	80N (6 Kg)	9024780244

### PISTÓN A GAS



Medida	Fuerza newtons	Ref.
244 mm	150N (13 Kg)	90236140N
244 mm	120N (10 Kg)	90236120N
244 mm	100N (8Kg)	90236100N
244 mm	80N (6 Kg)	9023680N
244 mm	60N (4 Kg)	9023660N
164 mm	80N (6 Kg)	9023616480
Pistón inverso	80N (6Kg)	90237

\* Consultar otras medidas

### SISTEMAS KIARO



\* Sistema de apertura horizontal inverso 7 Kg aproximadamente por mecanismo

Mecanismo Kiaro L600	Fijación superficie	Perfil L600
90246L600	90246F	90246T

\* Consultar otras medidas

Bisagra Kimana	80240
----------------	-------

### KIARO EASY



Fuerza	Kiaro Easy Soft	Kiaro Easy Strong
* Aproximado por mecanismo, el Jgo sería el doble	Hasta 3 Kg	Hasta 5 Kg
Kiaro Easy	90246TE	90246TES

Bisagra Kimana	80240
----------------	-------



# CAJONES

	PÁGINA
Cajón Hettich Avantech You .....	20-21
Cajón Hettich Arcitech .....	22-23
Cajón Hettich Atira .....	25-26
Cajón Tekno PRO .....	27
Cajón Teknoit .....	28-29
Sistemas de guías y correderas .....	30-31



El cajón AvanTech YOU destaca por una belleza perfecta gracias a su costado estrecho y recto. Y con la posibilidad de implementar con éxito sus propias ideas a partir de una amplia gama de opciones en cuanto a personalización y diseño y de la flexibilidad de diseño en colores, formas y materiales. Los perfiles de diseño, DesignCapes y elementos de inserción aportan un toque especial.

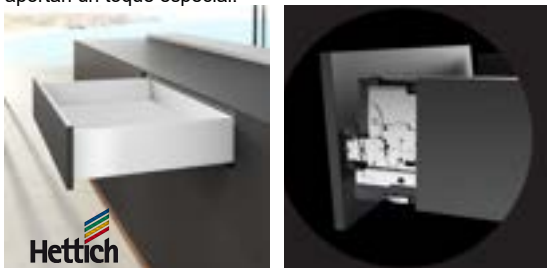

Un cajón, dos guías y numerosas funciones de confort. Se pueden combinar de manera flexible entre sí mediante un esquema de taladros uniforme. De esta manera, es posible atender a diferentes segmentos de mercado y áreas de aplicación de manera eficiente y orientada al cliente.



El amplio concepto plataforma y las sofisticadas adaptaciones de productos a los procesos de producción y montaje hacen de AvanTech YOU un sistema excelente en términos de rentabilidad y flujos de trabajo eficientes en una amplia gama de productos al mismo tiempo.

## AVANTECH YOU ANTRACITA

Fondo	77 mm	101 mm	139 mm	187 mm	251 mm
270		90HAVJL2710A		90HAVJL2718A	
300		90HAVJL3010A	90HAVJL3013A	90HAVJL3018A	
350		90HAVJL3510A	90HAVJL3513A	90HAVJL3518A	90HAVJL3525A
400	90HAVJL407A	90HAVJL4010A	90HAVJL4013A	90HAVJL4018A	90HAVJL4025A
450	90HAVJL457A	90HAVJL4510A	90HAVJL4513A	90HAVJL4518A	90HAVJL4525A
500	90HAVJL507A	90HAVJL5010A	90HAVJL5013A	90HAVJL5018A	90HAVJL5025A
550	90HAVJL557A	90HAVJL5510A	90HAVJL5513A	90HAVJL5518A	90HAVJL5525A
600		90HAVJL6010A	90HAVJL6013A	90HAVJL6018A	90HAVJL6025A
650		90HAVJL6510A		90HAVJL6518A	90HAVJL6525A

## AVANTECH YOU BLANCO

Fondo	77 mm	101 mm	139 mm	187 mm	251 mm
270		90HAVJL2710BL		90HAVJL2718BL	
300		90HAVJL3010BL	90HAVJL3013BL	90HAVJL3018BL	
350		90HAVJL3510BL	90HAVJL3513BL	90HAVJL3518BL	90HAVJL3525BL
400	90HAVJL407BL	90HAVJL4010BL	90HAVJL4013BL	90HAVJL4018BL	90HAVJL4025BL
450	90HAVJL457BL	90HAVJL4510BL	90HAVJL4513BL	90HAVJL4518BL	90HAVJL4525BL
500	90HAVJL507BL	90HAVJL5010BL	90HAVJL5013BL	90HAVJL5018BL	90HAVJL5025BL
550	90HAVJL557BL	90HAVJL5510BL	90HAVJL5513BL	90HAVJL5518BL	90HAVJL5525BL
600		90HAVJL6010BL	90HAVJL6013BL	90HAVJL6018BL	90HAVJL6025BL
650		90HAVJL6510BL		90HAVJL6518BL	90HAVJL6525BL

## AVANTECH YOU GRIS

Fondo	77 mm	101 mm	139 mm	187 mm	251 mm
270		90HAVJL2710G		90HAVJL2718G	
300		90HAVJL3010G	90HAVJL3013G	90HAVJL3018G	
350		90HAVJL3510G	90HAVJL3513G	90HAVJL3518G	90HAVJL3525G
400	90HAVJL407G	90HAVJL4010G	90HAVJL4013G	90HAVJL4018G	90HAVJL4025G
450	90HAVJL457G	90HAVJL4510G	90HAVJL4513G	90HAVJL4518G	90HAVJL4525G
500	90HAVJL507G	90HAVJL5010G	90HAVJL5013G	90HAVJL5018G	90HAVJL5025G
550	90HAVJL557G	90HAVJL5510G	90HAVJL5513G	90HAVJL5518G	90HAVJL5525G
600		90HAVJL6010G	90HAVJL6013G	90HAVJL6018G	90HAVJL6025G
650		90HAVJL6510G		90HAVJL6518G	90HAVJL6525G

## GUÍAS ACTRO Y QUADRO AVANTECH YOU



Un sistema de cajones, dos guías y un esquema de taladros idéntico permiten realizar una gran variedad de diseños de muebles para diferentes áreas de aplicación. Los muebles se diferencian por sus diversas funciones de confort.

Push to open Silent

Push to open Silent opcional para una apertura sin tiradores y un cierre con amortiguación

- Actro Capacidad de carga ideal en dos niveles (40 kg y 70 kg).

- Quadro Capacidad de carga hasta 30 kg

\* Consultar medidas y acabados

Guía	270 mm	300 mm	350 mm	400 mm	450 mm	500 mm	550 mm	600 mm	650 mm
Quadro 30Kg	90HAVQJG27	90HAVQJG30	90HAVQJG35	90HAVQJG40	90HAVQJG45	90HAVQJG50	90HAVQJG55	90HAVQJG60	
Actro 40Kg	90HAVAJG27	90HAVAJG30	90HAVAJG35	90HAVAJG40	90HAVAJG45	90HAVAJG50	90HAVAJG55	90HAVAJG60	
Actro 70Kg						90HAVAJG5070	90HAVAJG5570	90HAVAJG6070	90HAVAJG6570

### ADAPTADOR PARA CAJÓN DE MADERA



Con estos adaptadores se pueden usar las guías para cajón de madera

Actro	Quadro
90H925726364	90H925726061

### FIJACIONES DELANTERAS Y ESCUADRA ESTABILIZADORA

\* N° de escuadras recomendadas según ancho del cajón: Ancho <600mm (1ud.) | ≥600mm (2ud).. | ≥800mm (3ud). | =1200mm (5ud).

Altura de costado	77 mm	101 mm	139 mm	187 mm	251 mm
Fijaciones frontales tirafondos	90H9255832	90H9255835	90H9257884	90H9255838	90H9255838
Fijaciones para costados elementos de inserción				90H9257659	
Estabilizador para fijación de frente de costado de 251					90H9257887
Escuadra-estabilizador de trasera					90H9257702

## JGO. TAPA PERFIL AVANTECH



\* Consultar otras medidas y acabados

Fondo / Color	Antracita	Blanco	Inox	Cromo	Aluminio	Roble	Nogal
650 mm	90H9255830	90H9255821	90H9255776	90H9255785	90H9255767	90H9255794	90H9255803
600 mm	90H9255829	90H9255820	90H9255775	90H9255784	90H9255766	90H9255793	90H9255802
550 mm	90H9255828	90H9255819	90H9255774	90H9255783	90H9255765	90H9255792	90H9255801
500 mm	90H9255827	90H9255818	90H9255773	90H9255782	90H9255764	90H9255791	90H9255800
450 mm	90H9255826	90H9255817	90H9255772	90H9255781	90H9255763	90H9255790	90H9255799
400 mm	90H9255825	90H9255816	90H9255771	90H9255780	90H9255762	90H9255789	90H9255798
350 mm	90H9255824	90H9255815	90H9255770	90H9255779	90H9255761	90H9255788	90H9255797
300 mm	90H9255823	90H9255814	90H9255769	90H9255778	90H9255760	90H9255787	90H9255796
270 mm	90H9255822	90H9255813	90H9255768	90H9255777	90H9255759	90H9255786	90H9255795

## FRENTE INTERIOR (2000 mm)



\* Consultar otras medidas y acabados

Acabado	H-101 mm	H-139 mm	H-187 mm
Blanco	90H9257273	90H9257274	90H9257275
Antracita	90H9257277	90H9257278	90H9257279
<b>Perfil remate pieza cajón interior</b>			
Blanco	90H9257615	90H9257616	90H9257617
Antracita	90H9257619	90H9257620	90H9257621

## PUSH TO OPEN



Peso	Long. nominal	Quadro	Acto
< 10 Kg	270 -350 mm	90H9257894	90H9257890
8 – 20 Kg	> 270 mm	90H9257895	90H9257891
10 – 30Kg	> 270 mm	90H9257896	
10 – 40 Kg	> 270 mm		90H9257892
20 – 70 Kg	400 -650 mm		90H9257593
Varilla de sincronización (2 m)		90H9236718	

## SET LATERAL ELEMENTO INSERCIÓN H- 186 mm



\* Consultar otras medidas y acabados

\*\* Grosor de la inserción 10 mm (es posible menores con reductor)

\*\*\* Vale tanto para cristal como para otro material con un máximo de 10 mm

- Para Frentes de inserción consultar medidas, acabados y fijaciones

Color / Fondo	350 mm	400 mm	450 mm	500 mm	550 mm	600 mm	650 mm
Gris	90HAVCI9257173	90HAVCI9257174	90HAVCI9257175	90HAVCI9257176	90HAVCI9257177	90HAVCI9257178	90HAVCI9257179
Blanco	90HAVCI9257180	90HAVCI9257181	90HAVCI9257182	90HAVCI9257183	90HAVCI9257184	90HAVCI9257185	90HAVCI9257186
Antracita	90HAVCI9257187	90HAVCI9257188	90HAVCI9257189	90HAVCI9257190	90HAVCI9257191	90HAVCI9257192	90HAVCI9257193

# CAJÓN HETTICH ARCITECH

## SET CAJÓN ARCITECH CON GUÍA ACTRO (FRENO) 40kg



Acabado	Altura mm	270 mm	300 mm	350 mm	400 mm	450 mm	500 mm	550 mm	650 mm
Gris	94	90H279G	90H309G	90H359G	90H409G	90H459G	90H509G	90H559G	90H659G
Blanco	94	90H279BL	90H309BL	90H359BL	90H409BL	90H459BL	90H509BL	90H559BL	90H659BL
Antracita	94	90H279A	90H309A	90H359A	90H409A	90H459A	90H509A	90H559A	90H659A
Champagne	94	90H279CH	90H309CH	90H359CH	90H409CH	90H459CH	90H509CH	90H559CH	90H659CH
Gris	126	90H2712G	90H3012G	90H3512G	90H4012G	90H4512G	90H5012G	90H5512G	90H6512G
Blanco	126	90H2712BL	90H3012BL	90H3512BL	90H4012BL	90H4512BL	90H5012BL	90H5512BL	90H6512BL
Antracita	126	90H2712A	90H3012A	90H3512A	90H4012A	90H4512A	90H5012A	90H5512A	90H6512A
Champagne	126	90H2712CH	90H3012CH	90H3512CH	90H4012CH	90H4512CH	90H5012CH	90H5512CH	90H6512CH

\* El set incluye: Laterales, guías, tapas con Logo Hettich y fijaciones delanteras sin taco

\*\* Consultar guías de 70 Kg y fijaciones delanteras con taco.

## ENGANCHES TRASEROS PARA CAJÓN Y CACEROLERO



Acabado	78 mm	94 mm	126 mm	186 mm	218 mm	250 mm	282 mm
Gris	90HJET7G	90HJET	90HJET12G	90HJETCAG	90HJETC218	90HJETC25G	90HJETC28G
Blanco	90HJET7BL	90HJETBL	90HJET12BL	90HJETCBL	90HJETC218BL	90HJETC25BL	90HJETC282BL
Antracita	90HJET7A	90HJETA	90HJET12A	90HJETC18A	90HJETC218A	90HJETC25A	90HJETC28A
Champagne		90HJETCH	90HJET12CH	90HJETCA18CH	90H9150600	90HJETC25CH	90HJETC28CH

## BARRAS CUADRADAS PARA CACEROLEROS



Fijaciones delanteras para las barras

Sin tacos	90HJCB
Con taco de 10	90HJCBT

Altura / Fondo	270 mm	300 mm	350 mm	400 mm	450 mm	500 mm	550 mm	650 mm
Gris	90HJBCC27G	90HJBCC30G	90HJBCC35G	90HJBCC40G	90HJBCC45G	90HJBCCG	90HJBCC55G	90HJBCC65G
Blanco	90HJBCC27BL	90HJBCC30BL	90HJBCC35BL	90HJBCC40BL	90HJBCC45BL	90HJBCC50BL	90HJBCC55BL	90HJBCC65BL
Antracita	90HJBCC27A	90HJBCC30A	90HJBCC35A	90HJBCC40A	90HJBCC45A	90HJBCC50A	90HJBCC55A	90HJBCC65A
Champagne	90HJBCC27CH	90HJBCC30CH	90HJBCC35CH	90HJBCC40CH	90HJBCC45CH	90HJBCC50CH	90HJBCC55CH	90HJBCC65CH



## FIJACIONES DELANTERAS PARA CAJÓN INTERIOR



## BARRAS Y PIEZAS



CAJÓN

Acabado	94 mm	126 mm	186 mm	218 mm	Acabado	Barra 2 M	Pieza 2 M
Gris	90HJFDCIG	90HJFDCI12G	90HJFDCCIG	90HJFDCCI21G	Gris	90HBFCCIG	90H9192204
Blanco	90HJFDCIBL	90H9123087	90HJFDCCIBL	90HJFDCCI21BL	Blanco	90HBFCCIBL	90HPDCIBL
Antracita	90H140121	90H9140122	90HJFDCCIA	90H9140124	Antracita	90HBFCCIA	90H9192205
Champagne	90H9123085	90H9123088	90H9123091	90H9123094	Champagne	90H9182716	90H9192207

## TOPSIDE DOBLE PARED



- Doble pared Alturas 92 mm y 124 mm - Fondos desde 400 mm hasta 650 mm  
\* Consultar otras medidas y acabados

Acabado	Altura mm	400 mm	450 mm	500 mm	550 mm	650 mm
Gris	94	90H9122912	90H9122916	90HJT50G	90HJT55G	90HJT65G
Blanco	94	90H9122914	90H9122918	90HJT50BL	90HJT55BL	90HJT65BL
Antracita	94	90H9122913	90HJT45A	90H9122921	90HJT55A	90HJT65A
Champagne	94	90HJT40CH	90HJT45CH	90H9144527	90HJT55CH	90HJT65CH
Gris	126	90HJT4012G	90HJT4512G	90HJT5012G	90HJT5512G	90HJT6512G
Blanco	126	90H9122951	90H9122955	90H9122959	90HJT5512BL	90HJT6512BL
Antracita	126	90HJT4012A	90HJT4512A	90H9122958	90HJT5512A	90HJT6512A
Champagne	126	90HJT4012CH	90HJT4512CH	90HJT5012CH	90HJT5512CH	90HJT6512CH

## FIJACIÓN DESIGNSIDE



## DESIGNSIDE PARED DE CRISTAL



Acabado	92 mm	124 mm		300 mm	350 mm	400 mm	450 mm	500 mm	550 mm	650 mm
Gris	90H9122973	90H9122978								
Blanco	90H9122975	90H9122980								
Antracita	90H9122974	90H9122979	94	90H9122984	90H9122985	90H9122986	90H9122987	90H9122988	90H9122989	90H9122990
Champagne	90H9141689	90H9161767	126	90H9122992	90H9122993	90H9122994	90H9122995	90H9122996	90H9122997	90H9123078

Trasera de cajón 94 mm			
Acabado	Gris	Blanco	Antracita
300 mm	90HTC30G	90H9121376	90H9121402
350 mm	90HTC35G	90H9121378	90H9121404
400 mm	90HTC40G	90H9121380	90H9121406
450 mm	90HTC45G	90H9121382	90H9121408
500 mm	90HTC50G	90H9121384	90H9121410
600 mm	90HTC60G	90H9121388	90H9121414
700 mm	90HTC70G	90H9121390	90H9121416
800 mm	90HTC80G	90H9121392	90H9121418
900 mm	90HTC90G	90HTC90BL	90H9121420
1000 mm	90HTC100G	90H9121396	90H9121422
1200 mm	90HTC120G	90H9121400	90H9121426

## TRASERA METÁLICA



\* Consultar otras medidas y acabados

Trasera de cacerolero 186 mm			
Acabado	Gris	Blanco	Antracita
300 mm	90HTCC30G	90H9121532	90H9121558
350 mm	90HTCC35G	90H9121534	90H9121560
400 mm	90HTCC40G	90H9121536	90H9121562
450 mm	90HTCC45G	90H9121538	90H9121564
500 mm	90HTCC50G	90HTCC50BL	90H9121566
600 mm	90HTCC60G	90H9121544	90H9121570
700 mm	90HTCC70G	90HTCC70BL	90H9121572
800 mm	90HTCC80G	90H9121548	90H9121574
900 mm	90HTCC90G	90HTCC90BL	90H9121576
1000 mm	90HTCC100G	90H9121552	90H9121578
1200 mm	90H9121530	90H9121556	90H9121582

## FONDOS MELAMINA 16 mm

Acabado	Gris	Blanco	Antracita
300 mm	90HFC30	90HFC30BL	90HFC30A
350 mm	90HFC35	90HFC35BL	90HFC35A
400 mm	90HFC40	90HFC40BL	90HFC40A
450 mm	90HFC45	90HFC45BL	90HFC45A
500 mm	90HFC50	90HFC50BL	90HFC50A
600 mm	90HFC60	90HFC60BL	90HFC60A
700 mm	90HFC70	90HFC70BL	90HFC70A
800 mm	90HFC80	90HFC80BL	90HFC80A
900 mm	90HFC90	90HFC90BL	90HFC90A
1000mm	90HFC100	90HFC100BL	90HFC100A
1200mm	90HFC120	90HFC120BL	90HFC120A



\* Consultar otras medidas y acabados

## BANDA TRASERA MELAMINA 16 mm



2070 mm	H-94 mm	H-186 mm
Gris	90HBTC207	90HBTC0G
Blanco	90HBCBL	90HBCCBL
Antracita	90HBCA	90HBCCA

## SISTEMA PUSH TO OPEN PARA CAJÓN CON FRENO



Peso	Actro
10 – 40 Kg	90H9241050
20 – 80 Kg	90H9241051
Barra sincronizadora 2000mm	90H9236718

## ARRASTRADOR PARA CAJÓN INTERIOR



Acabado	Enganche interior
Gris	90H9235835
Gris Cuarzo	90H9235836
Antracita	90H9235834

## ESTABILIZADOR DE FRENTE



A partir de 600 mm (mayor sujeción)	
Plastico antracita	90H9123080

## PERFILES DECORATIVOS PARA COSTADOS ARCITECH



\* Consultar otras medidas y acabados

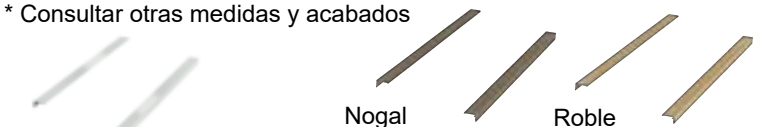

Inox

Aluminio

Nogal

Roble

Acabado	450 mm	500 mm	650 mm
Cromo	90H9240681	90H9240689	90H9240694
Aluminio	90H9240683	90H9240690	90H9240695
Acero inox	90H9240684	90H9240691	90H9240696
Roble	90H9240687	90H9240692	90H9240697
Nogal	90H9240688	90H9240693	90H9240698

## SET CAJÓN ATIRA



- Jgo lateral lacado metálico.
- Jgo Guías Quadro 30Kg.
- Jgo fijaciones al frente sin tacos
- Jgo tapas Hettich
- \* Consultar otras medidas y acabados

Acabado	300 mm	350 mm	420 mm	470mm	520 mm
Gris	90HA308G	90HA358G	90HA428G	90HA478G	90HA528G
Blanco	90HA308BL	90HA358BL	90HA428BL	90HA478BL	90HA528BL
Antracita	90HA308A	90HA358A	90HA428A	90HA478A	90HA528A

## JGO. ENGANCHES TRASEROS



Acabado	70 mm	144 mm	176 mm
Gris	90HJETI	90HJETCIG	90HJETCAIG
Blanco	90HJETIBL	90HJETCIBL	90HJETCAIBL
Antracita	90HJETIA	90HJETCIA	90HJETCAIA

## BARRAS CACEROLERO ATIRA



- \* Consultar otras medidas y acabados
- \*\* Consultar fijaciones con y sin taco.

Acabado	Gris	Blanco	Antracita
300 mm	90HJBCCATI30G	90HJBCCATI30BL	90HJBCCATI30A
350 mm	90HJBCCATI35G	90HJBCCATI35BL	90HJBCCATI35A
420 mm	90HJBCCATI42G	90HJBCCATI42BL	90HJBCCATI42A
470 mm	90HJBCCATI47G	90HJBCCATI47BL	90HJBCCATI47A
520 mm	90HJBCCATI52G	90HJBCCATI52BL	90HJBCCATI52A

## CAJÓN INTERIOR



Acabado	Fijaciones delanteras		Elementos delanteros	
	70 mm	144 mm	Barra 2M	Pieza 2M
Gris	90HJFDCIIG	90H9293516	90H9194614	90H9194764
Blanco	90HJFDCIIBL	90H9293517	90H9194615	90H9194765
Antracita	90H9196349	90H9293518	90H9194616	90H9194766

## TOPSIDE H-176



Top Side

Fijaciones

- \* Consultar otras medidas y acabados

Acabado	Topside	Adaptador 176 mm
Gris fondo 470 mm	90H9194702	90H9194660
Blanco fondo 470 mm	90H9194709	90H9194661
Antracita fondo 470 mm	90H9194716	90H9194662

## DESIGNSIDE



- \* Consultar otras medidas y acabados

Acabado	144 mm	176 mm
Gris fondo 470 mm	90H9194801	90H9194822
Blanco fondo 470 mm	90H9194808	90H9194829
Antracita fondo 470 mm	90H9194815	90H9194836

# CAJÓN HETTICH ATIRA

Trasera de cajón 70 mm			
Ancho	Gris	Blanco	Antracita
300 mm	90H1061901	90H9194439	90H9194452
350 mm	90H1061902	90H9194440	90H9194453
400 mm	90H1061903	90H9194441	90H9194454
450 mm	90H1061904	90H9194442	90H9194455
500 mm	90H1061905	90H9194443	90H9194456
600 mm	90H1061907	90H9194445	90H9194458
700 mm	90H1063664	90H9194446	90H9194459
800 mm	90H1062960	90H9194447	90H9194460
900 mm	90H1062961	90H9194448	90H9194461
1000mm	90H1063667	90H9194449	90H9194462
1200mm	90H9004102	9H9194450	90H9194463

## TRASERA METÁLICA



\* Consultar otras medidas y acabados

Trasera de cacerolero 176 mm			
Ancho	Gris	Blanco	Antracita
300 mm	90H9015064	90H9194494	90H9194506
350 mm	90H9015067	90H9194495	90H9194507
400 mm	90H9081520	90H9194496	90H9194508
450 mm	90H9015068	90H9194497	90H9194509
500 mm	90H9081521	90H9194498	90H9194510
600 mm	90H9015069	90H9194500	90H9194512
700 mm	90H9134074	90H9209982	90H9209984
800 mm	90H9081523	90H9194502	90H9194514
900 mm	90H9015071	90H9194503	90H9194515
1000mm	90H9081524	90H9194504	90H9194516
1200mm	90H9081525	90H9194505	90H9194517

Ancho	Gris	Blanco
300 mm	90HAFC30G	90HAFC30BL
350 mm	90HAFC35G	90HAFC35BL
400 mm	90HAFC40G	90HAFC40BL
450 mm	90HAFC45G	90HAFC45BL
500 mm	90HAFC50G	90HAFC50BL
600 mm	90HAFC60G	90HAFC60BL
700 mm	90HAFC70G	90HAFC70BL
800 mm	90HAFC80G	90HAFC80BL
900 mm	90HAFC90G	90HAFC90BL
1000 mm	90HAFC100G	90HAFC100BL
1200 mm	90HAFC120G	90HAFC120BL

## FONDOS MELAMINA 16 mm



\* Consultar otras medidas y acabados

## BANDA TRASERA 2070 mm PARA MELAMINA 16 mm



Acabado	70 mm	176 mm
Gris	90HBTCTATIG	90HBTCCATIG
Blanco	90HBTCTATIBL	90HBTCCATIBL
Antracita	90HBTCTATIA	90HBTCCATIA

## SISTEMA PUSH TO OPEN PARA CAJÓN CON FRENO



## ARRASTRADOR PARA CAJÓN INTERIOR



Peso	Quadro
10 – 30 Kg	90H9240163
30 – 50 Kg	90H9240164
Barra sincronizadora 2000mm	90H9236718

Acabado	Enganche interior
Gris	90H9235838
Antracita	90H9235837

\* Consultar otros acabados

## CAJÓN TEKNO PRO PERFIL FINO (ANTRACITA Y BLANCO)

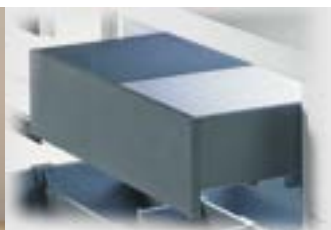

Cajón interior



Cajón con lateral de inserción cristal, (consultar medidas y disponibilidad)

CAJÓN

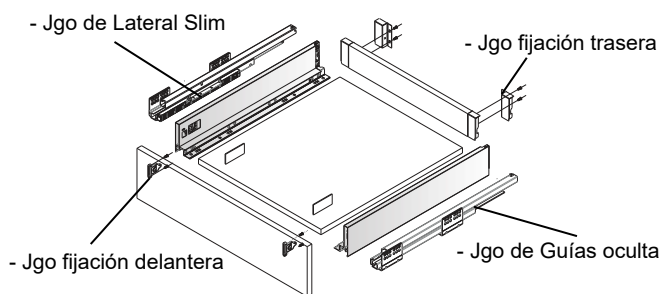

- Jgo de Guías oculta extracción total 40Kg
- Jgo de Laterales cajón doble pared slim
- Jgo de tapas para lateral cajón
- Jgo de fijaciones frontales y traseras (sin taco)

### SET TEKNO PRO ANTRACITA

Ancho	Alto		
	90 mm	128 mm	175 mm
Medida	90 mm	128 mm	175 mm
300mm	* Consultar	90TP300128GR	90TP300175GR
350mm	* Consultar	90TP350128GR	90TP350175GR
400mm	* Consultar	90TP400128GR	90TP400175GR
450mm	90TP45090GR	90TP450128GR	90TP450175GR
500mm	90TP50090GR	90TP500128GR	90TP500175GR

### SET TEKNO PRO BLANCO

Ancho	Alto		
	90 mm	128 mm	175 mm
Medida	90 mm	128 mm	175 mm
300mm	* Consultar	90TP300128BL	90TP300175BL
350mm	* Consultar	90TP350128BL	90TP350175BL
400mm	* Consultar	90TP400128BL	90TP400175BL
450mm	90TP45090BL	90TP450128BL	90TP450175BL
500mm	90TP50090BL	90TP500128BL	90TP500175BL

### PIEZAS CAJÓN INTERIOR

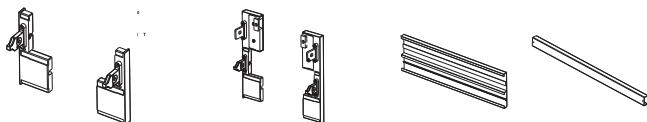

Color	Fijación H-9 mm	Fijación H-175 mm	Pieza 1100mm	Barra 100mm
Antracita	90TPJFDI9GR	90TPJFDI17GR	90TPPDIGR	90TPBIGR
Blanco	90TPJFDI9BL	90TPJFDI17BL	90TPPDIBL	90TPBIBL

### BANDA TRASERA MELAMINA 207 mm

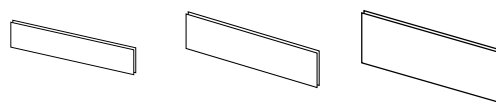

	90 mm	128 mm	175 mm
	90TPB2079A	90TPB20712A	90TPB20717A
	90TPB2079BL	90TPB20712BL	90TPB20717BL



### FONDO MELAMINA 16 mm

Medida	300 mm	350 mm	400 mm	450 mm	500 mm	600 mm	700 mm	800 mm	900 mm
Gris	90TPFC30A	90TPFC35A	90TPFC40A	90TPFC45A	90TPFC50A	90TPFC60A	90TPFC70A	90TPFC80A	90TPFC90A
Blanco	90TPFC30BL	90TPFC35BL	90TPFC40BL	90TPFC45BL	90TPFC50BL	90TPFC60BL	90TPFC70BL	90TPFC80BL	90TPFC90BL

\* Consultar otras medidas y acabados

## CAJÓN DOBLE PARED TEKNO IT CON FRENO



Cajón de extracción total con freno con guías desde 40 Kg.

Acabados Gris y Blanco en todas las medidas

\* Consultar otras medidas y acabados



CAJÓN Y CACEROLERO  
3 alturas



CAJÓN Y CACEROLERO  
INTERIOR



SOLUCIONES PARA  
ESQUINAS

# CAJÓN DOBLE PARED TEKNO IT CON FRENO

CAJÓN

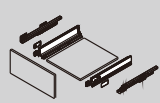

## Set de cajones

- Jgo de Guías oculta extracción total 40Kg
- Jgo de Laterales cajón doble pared
- Jgo de tapas para lateral cajón
- Jgo de fijaciones frontal cajón sin tacos.



## Juego barras Laterales Cuadradas

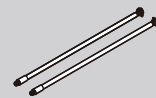

## Juego barras Laterales Redondas

Fondo	Gris	Blanco	SET
270mm	90T278G		1
300mm	90T308G	90T308BL	1
350mm	90T358G	90T358BL	1
400mm	90T408G	90T408BL	1
450mm	90T458G	90T458BL	1
500mm	90T508G	90T508BL	1

Fondo	Cuadradas		Redondas	
	Gris	Blanco	Gris	Blanco
300mm	90TJBCC30G	90TJBCC30BL	90TJBC30	90TJBC30BL
350mm	90TJBCC35G	90TJBCC35BL	90TJBC35	90TJBC35BL
400mm	90TJBCC40G	90TJBCC40BL	90TJBC40	90TJBC40BL
450mm	90TJBCC45G	90TJBCC45BL	90TJBC45	90TJBC45BL
500mm	90TJBCC50G	90TJBCC50BL	90TJBC50	90TJBC50BL

## ENGANCHES TRASEROS



Color	H- 83 mm	H- 141 mm	H-204 mm
Gris	90TJET	90TJETC	90TJETCA
Blanco	90TJETBL	90TJETCMBL	90TJETCBL

## FIJACIÓN DELANTERA CAJÓN/CACEROLERO INTERIOR

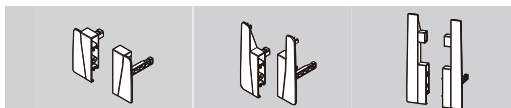

H- 83 mm	H- 141mm	Cuadrada H-204 mm	Redonda
90TJFDCI	90TJFDCCMG	90TJFDCCBCG	90TJFDCCI
90TJFDIBL		90TJFDCCIBL	

## BARRA DELANTERA CAJÓN INTERIOR 1100mm

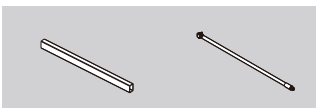

Cuadrada	Redonda
90TBCDG	90TBF
90TBDCBL	

CAJÓN ESQUINERO				
	Lateral	Guías	Fijaciones	
	Color	650 mm	650 mm	H-204
Gris	90TJLT65G	90TJG65FI	90TSC	90TS

FRENTE INTERIOR				
Tirador	Color	Barra cuadrada	Barra redonda	Pieza
90TTCCI	Gris	90TBCDG	90TBF	90TPD
	Blanco	90TBDCBL		90TPDIBL

BANDAS TRASERAS W-207 cm		
H- 83 mm	H- 204 mm	
90TBTC207G	90TBTC207G	
90TBC207BL	90TBCC207BL	

## TRASERA METÁLICA DE CAJÓN H-83 mm

Medida	300 mm	350 mm	400 mm	450 mm	500 mm	600 mm	700 mm	800 mm	900 mm	1000 mm
Gris	90TTC30G	90TTC35G	90TTC40G	90TTC45G	90TTC50G	90TTC60G	90TTC70G	90TTC80G	90TTC90G	90TTC100G
Blanco	90TTC30BL	90TTC35BL	90TTC40BL	90TTC45BL	90TTC50BL	90TTC60BL	90TTC70BL	90TTC80BL	90TTC90BL	90TTC100BL

## TRASERA METÁLICA DE CACEROLERO H-204 mm

Medida	300 mm	350 mm	400 mm	450 mm	500 mm	600 mm	700 mm	800 mm	900 mm	1000 mm
Gris	90TCC30G	90TCC35G	90TCC40G	90TCC45G	90TCC50G	90TCC60G	90TCC70G	90TCC80G	90TCC90G	90TCC100G
Blanco	90TCC30BL	90TCC35BL	90TCC40BL	90TCC45BL	90TCC50BL	90TCC60BL	90TCC70BL	90TCC80BL	90TCC90BL	90TCC100BL

## FONDOS DE MELAMINA 16 mm

Medida	300 mm	350 mm	400 mm	450 mm	500 mm	600 mm	700 mm	800 mm	900 mm	1000 mm	1200 mm
Gris	90TFC30	90TFC35	90TFC40	90TFC45	90TFC50	90TFC60	90TFC70	90TFC80	90TFC90	90TFC100	90TFC120
Blanco	90TFC30BL	90TFC35BL	90TFC40BL	90TFC45BL	90TFC50BL	90TFC60BL	90TFC70BL	90TFC80BL	90TFC90BL	90TFC100BL	90TFC120BL

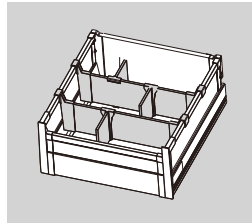

Divisor			
	Transversal	Pequeño	Fijación
	Color	90TDT	90TDP
Gris	90TDT	90TDP	90TFD
Blanco	90TDTBL	90TDPBL	90TFDBL

SUPLEMENTO PARED 500 mm		
* Para barras redondas		
Color	Simple	Doble
Gris H-204	90TJBXN	90TJBXD
Gris H-141	90TJBX	

FIJACIONES PARA CRISTAL	
Color	Jgo Fijaciones
Gris	90TJADC
Blanco	90TJADCBL

# GUÍAS PARA CAJÓN

## Guía oculta de extracción total (con freno incorporado o push to open)



Guías ocultas de extracción total 30Kg. incluye gatillos



Fondo	Freno ** 19 mm	Freno 16 mm	Push 16 mm
300mm	*	G30ETF	G30ETP
350mm	*	G35ETF	G35ETP
400mm	*	G40ETF	G40ETP
450mm	G4519ETF	G45ETF	G45ETP
500mm	G5019ETF	G50ETF	G50ETP
550mm	*	G55ETF	*
600mm	*	G60ETF	*

\* Consultar otras medidas y extracción parcial  
\*\* Para Laterales de cajón de 19 mm.

## Guía telescópica 3 cuerpos extracción total con freno



Guías telescópicas con rodamientos  
\* Extracción parcial para 250 y 300 mm (consultar)



Medida	Ref.	Medida	Ref.
350 mm	G35T	550 mm	G55T
400 mm	G40T	600 mm	G60T
450 mm	G45T	650 mm	G65T
500 mm	G50T	700 mm	G70T

## Guía corredera extracción parcial



Guías correderas 1.2 mm grosor con ruedas de nylon reforzado para cajón de madera



Medida	Blanca	Gris	Marrón
300 mm	90930	90930G	90930M
350 mm	90935	90935G	90935M
400 mm	90940	90940G	90940M
450 mm	90945	90945G	90945M
500 mm	90950	90950G	90950M
550 mm	90955	90955G	90955M
600 mm	90960	90960G	90960M

## Cajón metálico de extracción parcial y accesorios

Fondo/alto	GRIS			
	50 mm	85 mm	118 mm	150 mm
270 mm		90927T8G	90927T12G	90927T15G
300 mm		90930T8G	90930T12G	90930T15G
350 mm		90935T8G	90935T12G	90935T15G
400 mm		90940T8G	90940T12G	90940T15G
450 mm		90945T8G	90945T12G	90945T15G
500 mm	90950T5G	90950T8G	90950T12G	90950T15G

BLANCO		
85 mm	118 mm	145 mm
90927T8BL	90927T12BL	90927T15BL
90930T8BL	90930T12BL	90930T15BL
90935T8BL	90935T12BL	90935T15BL
90940T8BL	90940T12BL	90940T15BL
90945T8BL	90945T12BL	90945T15BL
90950T8BL	90950T12BL	90950T15BL

BARRAS CACEROLERO	
Fondo	500 mm
Gris cuadrada	90950JTL
Gris redonda	90950BCBG
Blanca redonda	90950BCBBL



Lateral metálico



Barras cuadradas y redondas cacerolero con fijaciones

## Freno para cajón de extracción parcial de madera y metálico

Fácil instalación, se recomienda poner doble freno para cajones más anchos de 500 mm



Color	Madera.	Metálico
Gris	90300	90301

## Expulsor cajón



Color	Ref.
Cromo	90250

Expulsor fuerte con regulación con base para atornillar.

## Cajón de PVC



Ancho	Blanco
300 mm	9033010
350 mm	9033510
400 mm	9034010
450 mm	9034510
500 mm	9035010
600 mm	9036010



## GUIAS ACTRO 5D



Acoplamiento

Regulación profundidad

Push

\* Consultar otras medidas y pesos.

Silent System - la amortiguación integrada cierra el cajón de forma suave y silenciosa  
 Cómodo montaje por deslizamiento con gatillos  
 Ajuste de altura intuitivo, sin herramientas hasta + 3 / - 1 mm, ajuste lateral hasta +/- 1,5 mm, ajuste radial hasta +/- 1,5 mm y ajuste de inclinación  
 Opcional: pedir por separado el ajuste de la profundidad  
 Opcional: sistema de apertura Push to open Silent  
 Capacidad de carga según EN 15338, nivel 3  
 Acero cincado, apropiado para entornos húmedos

\* Consultar otras medidas y pesos

Regulación y acoplamiento	
Acoplamiento	90H925726466
Profundidad	90H9257706

Push to open	
Peso	Ref
10 - 40 Kg	90H9257892
20 - 70 Kg	90H9257893
Barra sincro	90H9236718

Peso Medidas	350 mm	400 mm	450 mm	500 mm	650 mm	700 mm	750 mm
40 Kg	90HAVA5DJG35	90HAVA5DJG40	90HAVA5DJG45	90HAVA5DJG80	*	*	*
70 Kg	*	*	90HA5D70JG45	90HA5D70JG50	90HA5D70JG65	90HA5D70JG70	90HA5D70JG75

CAJÓN

## Separador de 9 mm. (Set 2 piezas) - puertas con bisagra de 110°

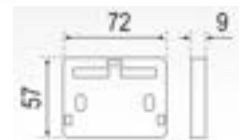

Separador para salvar puertas

Separador 9 mm

90D9

## Separador de 25 mm. (Set 2 piezas) - Para salvar las bisagras

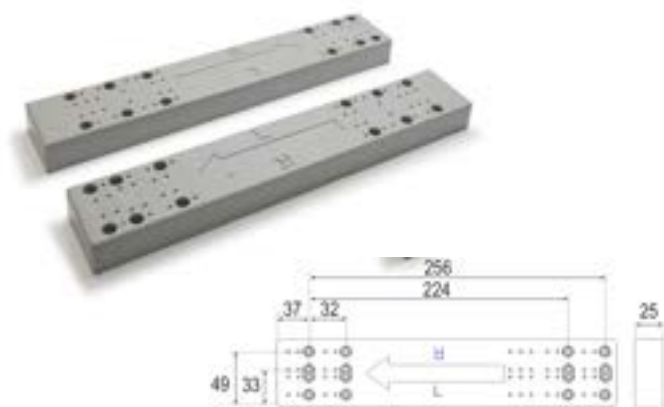

Separador para salvar bisagras

Separador 25 mm

90D25

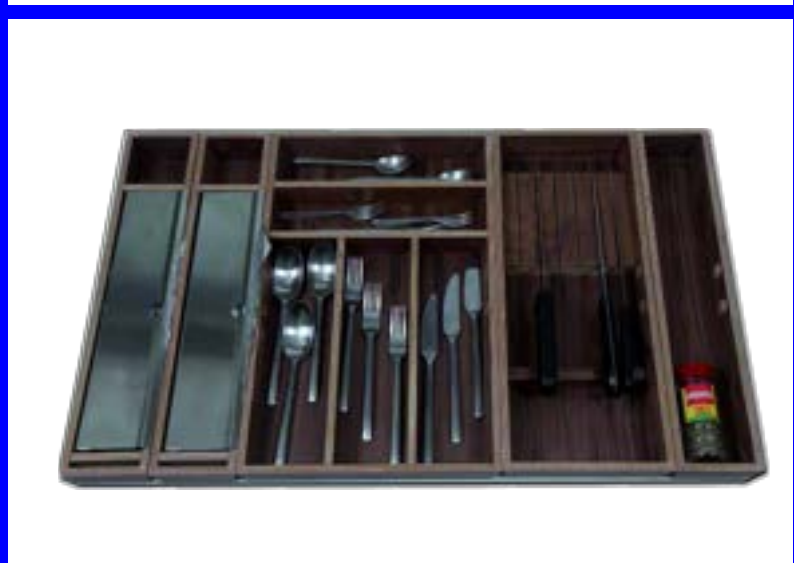

# ACCESORIOS CAJONES

	PÁGINA
Organizadores cajón/cacerolero .....	34-37
Organizadores Hettich .....	38-39
Organizadores de madera .....	40-41

# ACCESORIOS DE CAJÓN Y CACEROLERO

## CUBERTERO PVC GRIS



\* Consultar otras medidas

\*\* Las divisiones pueden variar respecto a las fotos

Modelo	300 mm	350 mm	400 mm	450 mm	500 mm	600 mm	700 mm	800 mm	900 mm	1000 mm	1200 mm
Extracción total con freno	90950B30G	90950B35G	90950B40G	90950B45G	90950B50G	90950B60G	90950B70G	90950B80G	90950B90G	90950B100G	90950B120G
Extracción parcial	9095030G	9095035G	9095040G	9095045G	9095050G	9095060G	9095070G	9095080G	9095090G	90950100G	90950120G

## CUBERTERO PVC BLANCO



\* Consultar otras medidas

\*\* Las divisiones pueden variar respecto a las fotos

Modelo	300 mm	350 mm	400 mm	450 mm	500 mm	600 mm	700 mm	800 mm	900 mm
Extracción total con freno	9095030E	90950B35BL	90950B40BL	90950B45BL	90950B50BL	90950B60BL	90950B70BL	90950B80BL	90950B90BL

## CUBERTERO SLIM PVC (cajón fino)



\* Consultar otras medidas

\*\* Las divisiones pueden variar respecto a las fotos

Modelo	400 mm	450 mm	500 mm	600 mm	700 mm	800 mm	900 mm
Antracita	90950TP40G	90950TP45G	90950TP50G	90950TP60G	90950TP70G	90950TP80G	90950TP90G
Blanco	90950TP40BL	90950TP45BL	90950TP50BL	90950TP60BL	90950TP70BL	90950TP80BL	90950TP90BL

## PLATERO EXTENSIBLE



Accesorios  
Cajón

Platero extensible	Gris
Platero adaptable para cacerolero	PLE

## SALVA SIFÓN MULTIMEDIDA



Medidas	Gris	Blanco	Antracita
Perfil salva sifón 2 metros altura 69 mm	90SFM	90SFBLM	90SFAM
Juego de fijaciones para salva sifón multimedita	90SFMJT	90SFBLMJT	90SFAMJT

## ORGANIZADOR SALVA SIFÓN

## SALVA SIFÓN

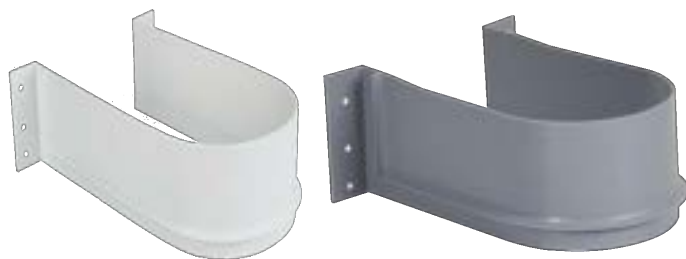

Cubertero salvasifón	Medidas	Gris	Blanco	Antracita
600 mm	245x150x86 mm	90SF	90SFBL	90SFA
9095060SF				

# ACCESORIOS DE CAJÓN Y CACEROLERO

## ESPECIEROS CUBERTEROS DE PLÁSTICO



Especiero de plástico	Nº botes	Gris
400 mm	18	90950EP40G
450 mm	21	90950EP45G
500 mm	24	90950EP50G
600 mm	30	90950EP60G

Especiero de plástico	Nº botes	Gris
Cubetero/especiero 800 mm	18	90950EPCU80G
Cubetero/especiero 900 mm	18	90950EPCU90G

## PLATERO DE PLÁSTICO



Platero PVC para cacerolero	Gris
600 mm	90950PT60G
900 mm	90950PT90G

## CUENCOS/BOLS ALUMINIO



Medida	Aluminio
497x150x54,5 (600) mm	70B60IN
697x150x54,5 (800)mm	70B80IN
797x150x54,5 (900) mm	70B90IN

## PLATERO ALUMINIO

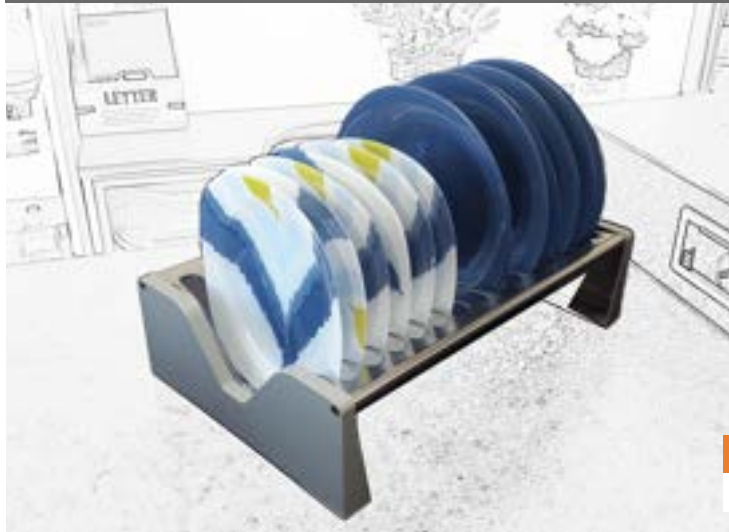

Capacidad	Medida	Aluminio
10 platos	295x255x114 mm	70E10

Accesorios  
Cajón

## CUBERTERO MODULAR ACERO

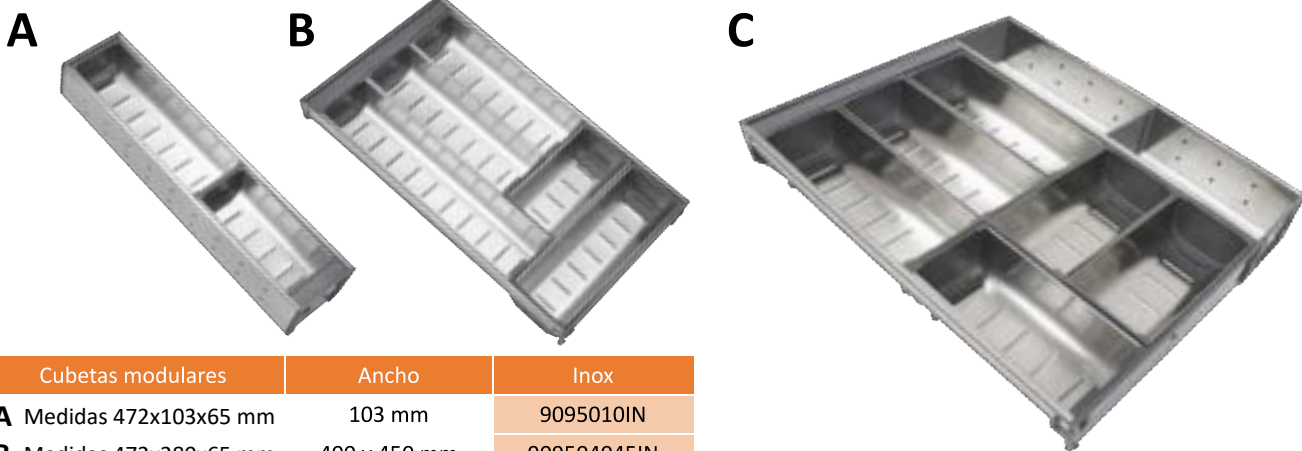

Cubetas modulares	Ancho	Inox
<b>A</b> Medidas 472x103x65 mm	103 mm	9095010IN
<b>B</b> Medidas 472x280x65 mm	400 y 450 mm	909504045IN
<b>C</b> Medidas 472x380x65 mm	500 y 600 mm	909505060IN

## ORGANIZADOR MODULAR ACERO



Organizador modular	Ancho	Inox
Medidas 480 x 290 mm	Desde 400 mm	90950DC

## CUBERTEROS HETTICH ORGATRAY



ORGATRAY 420 ARCITECH

ORGATRAY 440 ATIRA Y ARCITECH

NL	P	191	291	341	391	441	491	791
450	423							
500	473							
A		191	291	341	391	441	491	791
AM		300	400	450	500	550	600	900

P	170	200	250	300	350	400	450	500	550	600	650	700	750	800	850	900	950	1000
350																		
400																		
450																		
500																		
550																		
600																		
650																		
700																		
750																		
800																		
850																		
900																		
950																		
1000																		

NL = Longitud nominal P = Profundidad A = Ancho AM = Ancho del módulo

\* No es posible el empleo de insertos para cuchillos y espátulas

P = Profundidad A = Ancho AM = Ancho nominal

### CUBERTEROS AVANTECH YOU

Color / Medida	400 mm	450 mm	500 mm	600 mm	700 mm	800 mm	900 mm
ANTRACITA	9302770	9302771	9302772	9302773	9302774	9302775	9302776

### CUBERTEROS ARCITECH

Color/medida	400 mm	450 mm	500 mm	600 mm	700 mm	800 mm	900 mm
GRIS	90H9135574	90H9135575	90H9135577	90H9135580	90H9194938	90H9194938	90H9135592
BLANCO	90H9135615	90H9135616	90H9135617	90H9135619	90H9194969	90H9194970	90H9135620

### CUBERTEROS ATIRA

Color/medida	400 mm	450 mm	500 mm	600 mm	700 mm	800 mm	900 mm
GRIS	90950H40G	90950H45G	90950H60G	90950H60G	90950H70G	90950H80G	90950H90G

\* Fondo para cajón de 500 mm. Consultar otras medidas y colores

## CUBERTEROS MODULAR HETTICH

### CUBERTERO MODULAR ARCITECH

Medida/color	GRIS	BLANCO	ANTRACITA
300 mm	90H9134975	90H9135013	90H9183326
350 mm	90H9134976	90H9135014	90H9183327
400 mm	90H9134977	90H9135015	90H9183328
450 mm	90H9134979	90H9135016	90H9183329
500 mm	90H9134980	90H9135017	90H9183330
600 mm	90H9134992	90H9135019	90H9183332
800 mm	90H9134993	90H9135020	90H9183333
900 mm	90H9134994	90H9135031	90H9183334
1000 mm	90H9134995	90H9135032	90H9183335



\* Fondo para cajón de 500 mm. Consultar otras medidas y fondos



## PORTAOLLAS ORGAFLAG

## ORGANIZADOR SALVASIFÓN



Accesorios  
Cajón

Modelo	ARCITECH/AVANTECH			ATIRA		
	100 mm	600 mm	900 mm	100 mm	600 mm	900 mm
GRIS	90H9199904	90H9199902	90H9199903	90H9194871	90H9194869	90H9194870
BLANCO	90H9199910	90H9199908	90H9199909	90H9194877	90H9194875	90H9194876

SALVA SIFÓN ACERO	146x194x78.5 mm
PLATA	90H9204282
BLANCO	90HSFBL
ANTRACITA	90H9204284

## ORGANIZADOR DE CACEROLEROS ORGASTORE



\* Referencias de las bases, especificar número de separadores con el pedido

ORGASTORE ARCITECH FONDO 500mm							
Color/medida	300 mm	450 mm	600 mm	800 mm	900 mm	1000 mm	1200 mm
GRIS	90H9182254	90H9182255	90H9182256	90H9211067	90H9182257	90H9211078	90H9182258
BLANCO	90H9182259	90H9182260	90H9182261	90H9211652	90H9182262	90H9211653	90H9182263
ANTRACITA	90H9182264	90H9182265	90H9182266	90H9211654	90H9182267	90H9211655	90H9182268
ROBLE			90H9199647	90H9199648	90H9199649	90H9199650	
NOGAL			90H9199670	90H9199671	90H9199672	90H9199673	

ORGASTORE ATIRA FONDO 500mm							
Color/medida	300 mm	450 mm	600 mm	800 mm	900 mm	1000 mm	1200 mm
GRIS	90H9194839	90H9194841	90H9194843	90H9194844	90H9194845	90H9194846	90H9194847
BLANCO	90H9194848	90H9194850	90H9194852	90H9194853	90H9194854	90H9194855	90H9194856
ANTRACITA	90H9194857	90H9194859	90H9194861	90H9194862	90H9194863	90H9194864	90H9194865

# ACCESORIOS DE MADERA

## CUBERTEROS MADERA SERIE BASIC

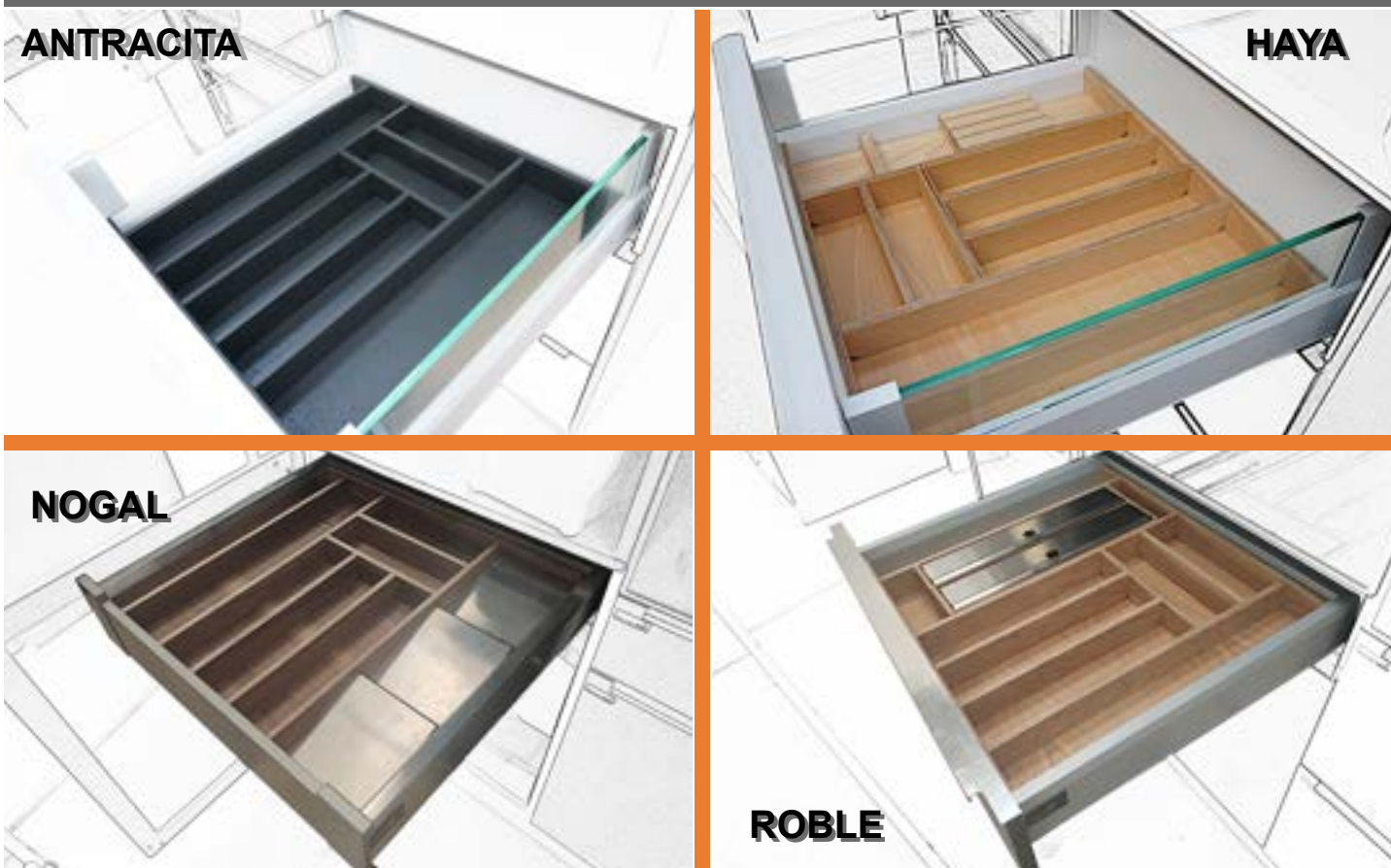

Color/medida	300 mm	350 mm	400 mm	450 mm	500 mm	600 mm	900 mm	1200 mm
HAYA	9050300MHY	9050350MHY	9050400MHY	9050450MHY	9050500MHY	9050600MHY	9050900MHY	90501200MHY
ROBLE	9050300MRB	9050350MRB	9050400MRB	9050450MRB	9050500MRB	9050600MRB	9050900MRB	90501200MRB
NOGAL	9050300MNO	9050350MNO	9050400MNO	9050450MNO	9050500MNO	9050600MNO	9050900MNO	90501200MNO
ANTRACITA	9050300MA	9050350MA	9050400MA	9050450MA	9050500MA	9050600MA	9050900MA	90501200MA

\* Compatibles con cualquier fabricante de cajón (indicar al realizar el pedido).

\*\* Consultar acabados y medidas (la configuración del cubertero variará en función del tamaño requerido).

\*\*\* Indicar los accesorios requeridos al realizar el pedido.

## ACCESORIOS SERIE BASIC



Cuchillero

Portarrollo con corta papel

Soporte especiero Acero 85X125

Accesorios Cuberteros Madera	Haya	Roble	Nogal	Antracita
Portarrollos con cortapapel	9050PRHY	9050PRR	9050PTN	9050PTA
Cuchillero (12 cm)	9050CUCHY	9050CUCR	9050CUCN	9050CUCA
Soporte especiero Acero 85X125	9050SE			

## ACCESORIOS CACEROLERO



Accesorios  
Cajón



Box 1

Box 2

Box 3 sartenero

Alto:	160	Alto:	160	Alto:	160
Fondo:	470	Fondo:	234	Fondo:	380
Ancho:	260	Ancho:	260	Ancho:	260

\* Compatible con cualquier fabricante de cajón (indicar al realizar el pedido).

\*\* Consultar otras medidas y acabados

\*\*\* Consultar disponibilidad botes y volumen.

### PORTABOTES

Medidas	300 mm	400 mm	600 mm	900 mm	1200 mm
Nº Botes	( 3 botes )	( 6 botes )	( 9 botes )	( 12 botes )	( 18 botes )

Accesorios Cacerolero	Haya	Roble	Nogal	Antracita
Box 1 260x470x160	9050XH1HY	9050XH1R	9050XH1N	9050XH1AN
Box 2 260x234x160	9050XH2HY	9050XH2R	9050XH2N	9050XH2AN
Box 3 260x380x160	9050XH3HY	9050XH3R	9050XH3N	9050XH3AN

Accesorios Cacerolero	Haya	Roble	Nogal	Antracita
Portabotes 300 mm	9050XBB300HY	9050XBB300R	9050XBB300N	9050XBB300AN
Portabotes 400 mm	9050XBB400HY	9050XBB400R	9050XBB400N	9050XBB400AN
Portabotes 600 mm	9050XBB600HY	9050XBB600R	9050XBB600N	9050XBB600AN
Portabotes 900 mm	9050XBB900HY	9050XBB900R	9050XBB900N	9050XBB900AN
Portabotes 1200mm	9050XBB120HY	9050XBB120R	9050XBB120N	9050XBB120AN

## PORTAOLLAS

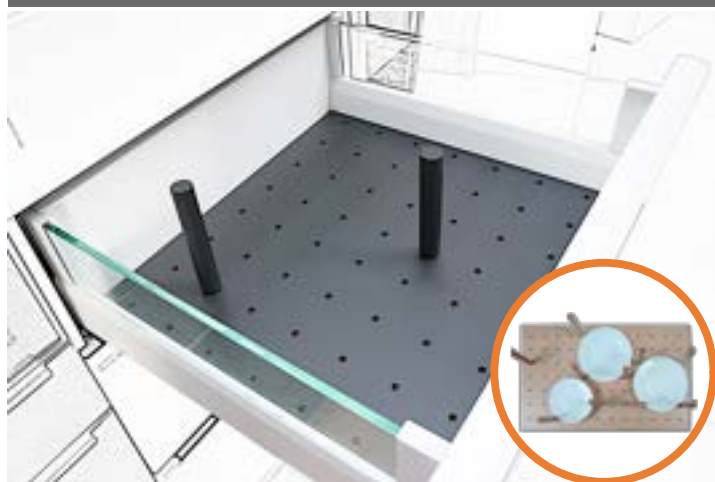

\* Compatible con cualquier fabricante de cajón (indicar al realizar el pedido).

Medidas	600 mm	900 mm	1200 mm
HAYA	905060OM	905090OM	9050120OM
ROBLE	905060PMR	905090PMR	9050120PMR
NOGAL	905060PMN	905090PMN	9050120PMN
ANTRACITA	905060PA	905090PMA	9050120PMA

## PLATERO



\* Compatible con cualquier fabricante de cajón (indicar al realizar el pedido).

Medidas	600 mm	900 mm	1200 mm
HAYA	700600PMHY	700900PMHY	7001200PMHY
ROBLE	700600PMRB	700900PMRB	7001200PMRB
NOGAL	700600PMNO	700900PMNO	7001200PMNO
ANTRACITA	700600PMA	700900PMA	7001200PMA

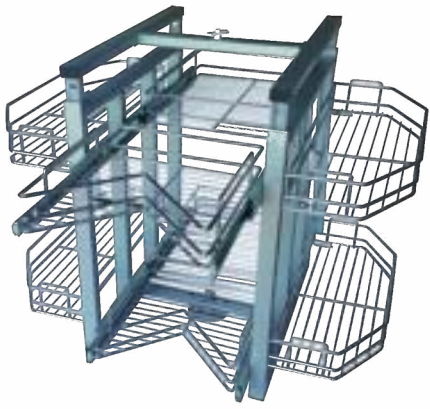

# ALAMBROS ACCESORIOS

	PÁGINA
Protectores y rejillas .....	44
Escurreplatos y vasos .....	45
Accesorios de alambre .....	46-50
Cestos de ropa .....	51
Cubos de basura .....	52-55

# PROTECTORES Y REJILLAS

## PROTECTOR FONDO FREGADERO

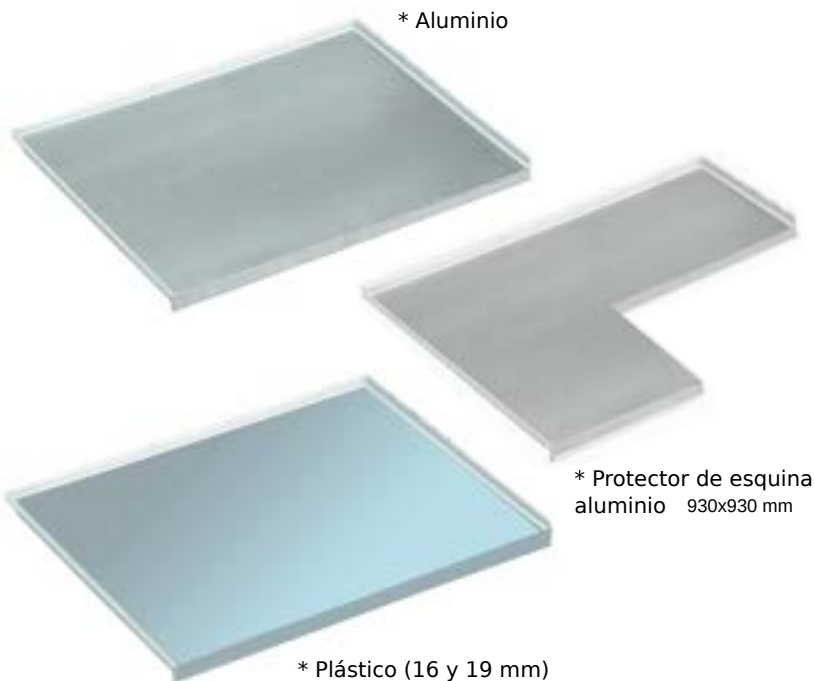

Todos los protectores tienen un fondo de 580 mm. Los protectores de plástico sirven para cascos de 16 mm y de 19 mm

Consultar Protectores de 19 mm en aluminio

Medidas	Aluminio	Plástico
400 mm	7024058GJ	7024058PJ
450 mm	7024558GJ	7024558PJ
500 mm	7025058GJ	7025058PJ
600 mm	7026058GJ	7026058PJ
700 mm	7027058GJ	7027058PJ
800 mm	7028058GJ	7028058PJ
900 mm	7029058GJ	7029058PJ
1000 mm	70210058GJ	70210058PJ
1100 mm	70211058GJ	70211058PJ
1200 mm	70212058GJ	70212058PJ
930x930 mm	702909058GJ	

## ESTERILLA ANTI-DESLIZANTE



Medidas 480 mm	Rollo 20 metros	Rollo 1.5 metros	Por metros
Gris textil	90BRAGRR20	90BRAG15	90BRATG
Blanco textil	90BRATBL20	90BRATBL15	90BRABL
Antracita textil	90BRATA20	90BRATA15	90BRATA

### REJILLA AIREACIÓN CUADRADA FRIGORÍFICO



8 Lamas Altura 120 mm	Inox	Plata Mate	Blanca	Negra
600 mm	60400IN	40100CR	4010010	4010019
700 mm	6040070IN		6040070BL	
900 mm			6040090BL	6040090NG
1000 mm			604001BL	
1200 mm	60400120IN			

### REJILLA AIREACIÓN VITROCERÁMICA INDUCCIÓN



\* Consultar disponibilidad de otras medidas

H- 30mm	600 mm	700 mm	800 mm	900 mm
INOX	60302IN	6030270IN	6030280IN	6030290IN
BLANCA	60302BL	6030270BL	6030280BL	6030290BL
H- 20mm	600 mm	700 mm	800 mm	900 mm
INOX	60302IN2	60302702IN	6030280IN2	6030290IN2
BLANCA	60302BL2	6030270BL2	6030280BL2	6030290BL2

### REJILLA AIREACIÓN PARA HORNO



Medida	Inox	Blanca	Negra
600 x 85 mm	60300IN	60300BL	60300NG

### REJILLA ZÓCALO



Medida	Plata mate	Blanca
480x60 mm	60301AL	60301BL

## ESCURREPLATOS ABATIBLE ACERO INOXIDABLE



Detalle Muelle



## ACCESORIOS ESCURREPLATOS



\* Consultar otras medidas.

Medidas	Inox	Medidas	Inox
400 mm	70140IN	700 mm	70170INA
450 mm	70145IN	800 mm	70180INA
500 mm	70150INA	900 mm	70190INA
600 mm	70160INA	1000 mm	701100IN

Accesorios para escurreplatos	Plastico
Platero 250x220 mm (9 platos)	70AEP
Platero cubertero 266x473 mm (5 platos)	70ACPP

Alambre Cestos

## JUEGO REJILLAS ESCURREPLATOS Y BANDEJA

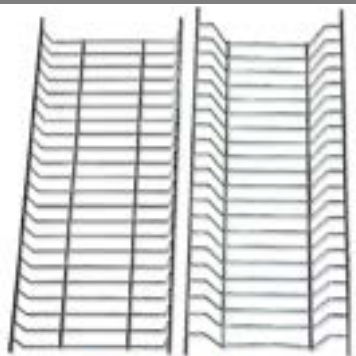

Rejillas escurreplatos en PVC e Inox



Bandeja recogeaguas

\* Solo para rejilla de PVC

Color/medida	400 mm	450 mm	500 mm	600 mm	700 mm	800 mm	900 mm	1000 mm
Escurreplatos PVC	700100PPVC	700110PPVC	700150PPVC	700310PPVC	700210PPVC	700510PPVC	700610PPVC	700710PPVC
Escurrevasos PVC	700100VPVC	700110VPVC	700150VPVC	700310VPVC	700210VPVC	700510VPVC	700610VPVC	700710VPVC
Escurreplatos inox	700100PX	700110PX	700150PX	700310PX	700210PX	700510PX	700610PX	700710PX
Escurrevasos inox	700100VX	700110VX	700150VX	700310VX	700210VX	700510VX	700610VX	700710VX
Bandeja PVC	70BEG40	70BEG45	70BEG50	70BEG60	70BEG70	70BEG80	70BEG90	

## JUEGO ESCURREPLATOS PVC INYECTADO

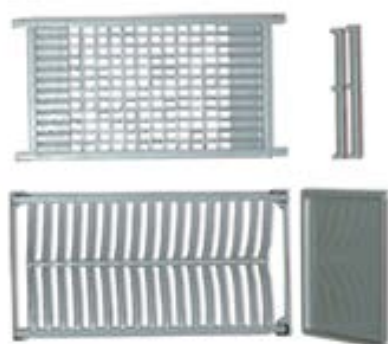

Escurreplatos PVC inyectado	Blanco	Beige
400 mm	70140	7014022
450 mm	70145	7014522
500 mm	70150	7015022
600 mm	70160	7016022
700 mm	70170	7017022
800 mm	70180	7018022
900 mm	70190	7019022

## BOTELLERO ESPECIERO GUÍAS HETTICH



Modelos 150 y 200 mm  
\* Indicar lado de la guía

Modelos 250 mm

Modelos 300 - 500 mm  
\* Foto altura 80



Fijación

Divisor Botellero



\* Extracción total con freno

Altura	700 mm	800 mm
150 mm	70713CR15F	7071380CR15F
200 mm	70713CR20F	7071380CR20F
250 mm	707725CR	707725H80CR
300 mm	70730BVCRB	70730BV80CRB
350 mm	7071353PCR	70735BVCRB
400 mm	70740BVFCR	70740BV80CR
500 mm	70750BCRF	70750BCRF80

### VERDULERO TRIPLE GUÍAS HETTICH



### PANERO BOTELLERO GUÍAS HETTICH



Fijación



\* Extracción total con freno

\* Extracción total con freno

Cromo	Ancho	250 mm	300 mm	350 mm	400 mm	450 mm	500 mm
VERDULERO TRIPLE	700		70730VTCRB	707135VCR	70740VTCRF	70745VTFCR	707450CR
	800		70730BV80CRB	70735VT80CR	70740VT80CR	70745VT80FCR	70750VT80CRB
BOTELLERO PANERO	700	70710025CRF	707100CRF	70710035CRF	707200CRF	707400PCR	7071250CR
	800	7071002580CRF	707100CRF80	7071003580CRF	70720080CRF	70740080PCR	7071250CR80

### BOTELLEROS LUXE

### MUEBLE RINCÓN REVERSIBLE



\* Extracción total con freno

Ancho	Cromo
150 mm	70713L15CR
200 mm	70713L20CR



Mueble rincón reversible

Extracción total

- 4 cestos
- Puertas de 400, 450 y 500
- Acabado en cromo

\*Consultar otras medidas

Ancho puerta	Sin freno	Con freno
400 mm	70810040CR	70810040FCR
450 mm	70810045CR	70810045FCR
500 mm	70810050CR	70810050FCR



# BOTELLEROS ELIPTICOS GUÍAS HETTICH



Fijación



Divisor Botellero

Modelo	Altura	150 mm	200 mm	250 mm	300 mm	350 mm	400 mm	500 mm
Cromo elíptico	700 mm	7071315FECECR	7071320FECECR	707725BVECECR	70730BVECECR	70735BVFECECR	70740BVFECECR	7071350FECECR
Antracita elíptico	700 mm	7071315FA	7071320FA	707725FA	70730BVFA	70735BVFA	70740BVFA	70750BVFA
Jgo. Bandeja gris	700 mm	70713B15G	70713B20G	70713B25G	70713BB30G	70713BB35G	70713BB40G	70713BB50G
Jgo. Bandeja Antracita	700 mm	70713B15A	70713B20A	70713B25A	70713B30A	70713B35A	70713B40A	70713B50A
Cromo elíptico	800 mm	7071380ECR15F	707132080ECR	707725H80ECR	70730BV80ECR	70735BV80ECR	70740BV80ECR	70750BV80ECR
Antracita elíptico	800 mm	7071380A15F	707132080EA	707725H80EA	70730BV80EA	7071380FA35	70740BV80A	7071380FA50
Jgo. Bandeja gris	800 mm	70713B1580G	70713B2080G	70713B2580G	70713B3080G	70713B3580G	70713B4080G	70713B5080G
Jgo. Bandeja Antracita	800 mm	70713B1580A	70713B2080A	70713B2580A	70713B3080A	70713B3580A	70713B4080A	70713B5080A

Alambre Cestos

# VERDULERO TRIPLE ELÍPTICO GUÍAS HETTICH



Ancho	Cromo elíptico		Antracita elíptico	
	700	800	700	800
300 mm	70730VTECR	70730VT80ECR	70730VTFA	70730VT80FA
350 mm	70735BVFECECR	70135VT80CRF	70735VTFA	70735VT80EA
400 mm	70740VTFECECR	70740VT80ECR	70740VTFA	70740VT80FA
450 mm	70745VTECR	70745VT80ECR	70745VTFA	70745VT80FA
500 mm	70750VTECR	70750VT80ECR	70750VTFA	70750VT80FA
Ancho	Jgo. Bandeja Gris		Jgo. Bandeja antracita	
300 mm	70713BVT30G		70713BVT30A	
350 mm	70713BVT35G		70713BVT35A	
400 mm	70713BVT40G		70713BVT40A	
450 mm	70713BVT45G		70713BVT45A	
500 mm	70713BVT50G		70713BVT50A	

# PANERO BOTELLERO ELÍPTICO GUÍAS HETTICH



Ancho	Cromo elíptico		Antracita elíptico	
	700	800	700	800
250 mm	707BP25ECRF	707BP25ECR80F	707BP25EAF	707BP25EA80F
300 mm	707BP30ECRF	707BP30ECR80F	707BP30EAF	707BP30EA80F
350 mm	707BP35ECRF	707BP35ECR80F	707BP35EAF	707BP35EA80F
400 mm	707BP40ECRF	707BP40ECR80F	707BP40EAF	707BP40EA80F
450 mm	707BP45ECRF	707BP45ECR80F	707BP45EAF	707BP45EA80F
500 mm	707BP50ECRF	707BP50ECR80F	707BP50EAF	707BP50EA80F
Ancho	Bandeja Gris		Bandeja antracita	
250 mm	70713BP25G	70713BP2580G	70713BP25A	70713BP2580A
300 mm	70713BP30G	70713BP3080G	70713BP30A	70713BP3080A
350 mm	70713BP35G	70713BP3580G	70713BP35A	70713BP3580A
400 mm	70713BP40G	70713BP4080G	70713BP40A	70713BP4080A
450 mm	70713BP45G	70713BP4580G	70713BP45A	70713BP4580A
500 mm	70713BP50G	70713BP5080G	70713BP50A	70713BP5080A



# ACCESORIOS DE ALAMBRE

## MUEBLE RINCÓN REVERSIBLE ELIPTICO



Mueble rincón reversible sin freno con varillas elípticas, acabados en cromado y antracita.

\* Consultar otras medidas

Acabado	400 mm	450 mm	500 mm
Elíptico cromo	70810040ECR	70810045ECR	70810050ECR
Elíptico Antracita	70810040EA	70810045EA	70810050EA
Bandeja Gris	70713BR40G	70713BR45G	70713BR50G
Bandeja Antracita	70713BR40A	70713BR45A	70713BR50A

## TORNO GIRATORIO 3/4



Acabado	Ø mm	Altura mm	Cromo
Madera	820	700-800	702800M3/482AL
Alambre	820	700-800	708003/482CR
Alambre	720	700-800	708003/4CR

## TORNO GIRATORIO SIMPLE



Torno 2 bandejas giratoria	Altura	Cromo
Torno giratorio simple	700 a 800mm	702800/1CR

# MUEBLE RINCÓN 270º



Mueble rincón 900x900mm H-70 y H-80 mm	Cromo
Extracción total giratorio 270º	709000CR

Alambre Cestos

# MUEBLE RINCÓN CON FRENO DOBLE BANDEJA CON EJE



Condena derecha Condena izquierda

\* Extensibles para altura 700 a 800 mm  
\*\* Consultar otras medidas.



Puertas de 450 mm	Cromo	Antracita
Condeja izquierda	708101FRIZ	708101FRIZA
Condena derecha	708101FRDE	708101FRDEA

# CESTO CACEROLERO EXTRACCIÓN TOTAL CON FRENO



\* Altura del cesto 120 mm



Color	400 mm	450 mm	500 mm	600 mm
Cromo	704050CCR	704550CCR	705050CCR	7060050SBCR
Blanco	704050BLC	704550BLC	705050BLC	7060050SBLC

# ACCESORIOS DE ALAMBRE

## DESPENSERO EXTRAIBLE EXTENSIBLE CON FRENO



## COLUMNA BOTELLERO CON FRENO

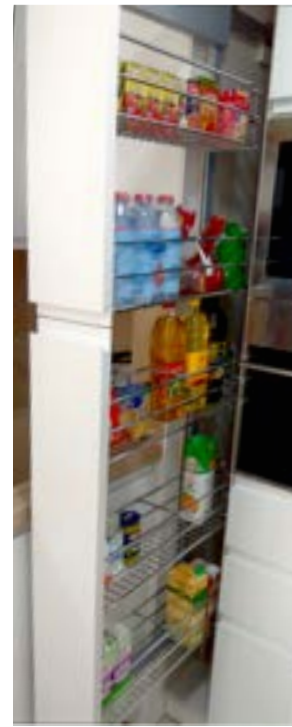

\* Acabado en cromo \*\* Consultar otros acabados y medidas \*\*\* Especificar mano de las guías al realizar el pedido.

Altura Ancho	300 mm	400 mm	450 mm	600 mm	Ancho casco	Altura 1300 mm	Altura 1800 mm
1850-2200	708500GECRF	708600GECRF	708700GECRF	708900GECRF	150 mm	70714130CR	70714180CR
1300-1700	708500ECRF	708600ECRF	708700ECRF	708900ECRF	200 mm	7071413020CR	7071418020CR
					250 mm	7071413025CR	7071418025CR

## VERDULERO EXTRACCIÓN TOTAL CON FRENO



\* Acabado en cromo y antracita con varilla elíptica.  
 \*\* Altura del cesto, H-120  
 \*\*\* Consultar otros acabados y medidas

Color	300 mm	350 mm	400 mm	450 mm	500 mm
Cromo	70330CR	70335CR	70340CRFE	70345CRFE	70350CRFE
Antracita	70330EAF	70335EAF	70340EAF	70345EAF	70350EAF
Color	500 mm	600 mm	700 mm	800 mm	900 mm
Cromo	70350CRFE	70360CREF	70370CRF	70380CR	70390CREF
Antracita	70350EAF	70360EAF	70370EAF	70380EAF	70390EAF

## CESTO CON FRENO BAJO FREGADERO



Acabado	600 mm	800 mm	900 mm
Cromo	70BF60	70BF80	70BF90

## CARRO BUTANO EXTRACCIÓN TOTAL

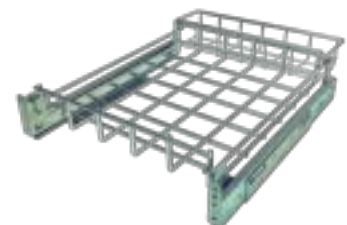

Medida	Cromo
400 mm	90126CR

## CESTO EXTRAIBLE CON ASA O FIJACIÓN AL FRENTE



706730EP



706730A

Medidas (Ancho x Fondo x Altura)	Cubos	Cesto extraible plástico	Asa cesto de ropa	Juego escudras para frente
300 mm (248x477x570 mm)	1 ( 35 Litros)	706730EP	706730A	70673045E
450 mm (392x497x570 mm)	2 ( 35 Litros)	706745EP	706745A	70673045E

Alambre Cestos

## CESTO COLGANTE CAJÓN



Medidas (Ancho x Fondo x Altura)	Cubos	Cesto colgante plástico
400 mm (368X506X570)	1 ( 35 L)	706740CPBL
450 mm (418X506X570)	1 ( 48 L)	706745CPBL
600 mm (568X506X570)	2 ( 35L)	706760CPBL

## CESTO ABATIBLE PLÁSTICO



Medidas (Ancho x Fondo x Altura)	Cubos	Cesto abatible plástico
450 mm (400x346x530)	1 ( 48 L)	706745PBL

## CESTO GUIAS HETTICH



Ancho	Cesto Guías Hettich cromo	Ancho	Cesto Guías Hettich cromo
300 mm	70670030CRG	450 mm	706700/2GCR
350 mm	70670035GCR	500 mm	70670050GCR
400 mm	706700/1GCR	600 mm	706700GCR

## CESTO ABATIBLE CROMO



Ancho	Cesto Guías Hettich cromo	Ancho	Cesto Guías Hettich cromo
300 mm	70670030CR	450 mm	706700/2CR
350 mm	70670035	500 mm	70670050CR
400 mm	706700/1CR	600 mm	706700CR

# CUBOS DE BASURA

## CUBO COLGANTE CAJÓN



\* para cajón extracción con freno



\* para cajón extracción con freno

Cubetas	Volumen	Ancho	Cubo colgante
2	2x35 L	600 mm	90123CC60

Cubetas	Volumen	Ancho	Cubo colgante
2	2x27 L	450 mm	90123CC45

## CUBO COLGANTE CAJÓN CON BANDEJA EXTRACCIÓN TOTAL



\* para cajón extracción con freno



\* para cajón extracción con freno

Cubetas	Volumen	Ancho	Cubo colgante
4	2x31 L 2x16	600 mm	90123M6094L

Cubetas	Volumen	Ancho	Cubo colgante
2	2x37 L	450 mm	90123M4574L

## CUBO MULTIUSOS



Cubetas	Ancho	Cubo colgante frente
1x 5 Litros	250 mm	90123T5

## CUBOS ECOLÓGICOS

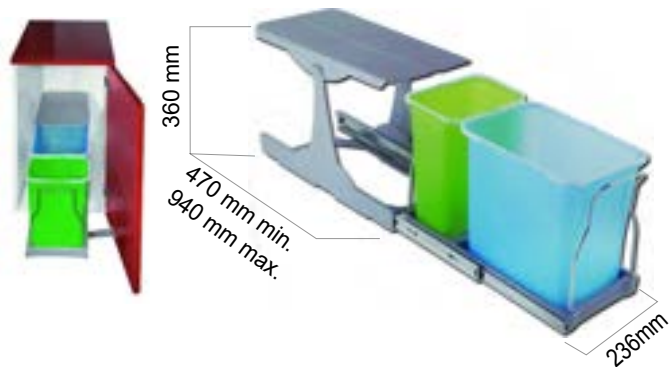

\* Apertura con puerta para frente de 400 mm (opcional)

Cubetas	Volumen	Ancho	Cubo ecológico
2	1x 16L y 1x 8L	300 mm*	90123PT40

Cubetas	Volumen	Ancho	Cubo ecológico
2	2x 16L	400 mm	90123EE402

Alambre  
Cestos



Cubetas	Volumen	Ancho	Cubo ecológico
2	2x 16L 1x bandeja	400 mm	90123T40

Cubetas	Volumen	Ancho	Cubo ecológico
2	1x 16L 1x 8L	350 mm	901239035

## CUBO COLGANTE PUERTA

## ENCASTRE

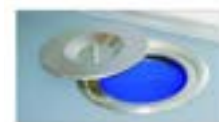

Cubo colgar	16 Litros
Gris	90123SCR

Cubo colgar	13 Litros
Gris	90123P40

Cubo colgar	Cromo brillo
14 LITROS	90123CR

CUBO ENCASTRABLE	90123ECR
------------------	----------

# CUBOS DE BASURA

## CUBO COLGANTE PARA PUERTA

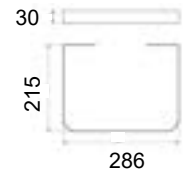
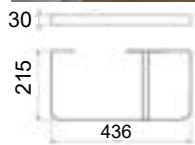

Cubetas	Volumen	Ancho puerta	Cubo colgante
2	1x 15L 1x 7L	600 mm	90123B60

Cubetas	Volumen	Ancho	Cubo colgante
1	1x 15L	450 mm	90123B45

## CUBO TANDEM



Cubetas	Volumen	Ancho Mueble	Cubo tandem
3	1x 34L 2x 12L	400 mm	901239124

Cubetas	Volumen	Ancho	Tandem fij. frontal
3	1x 34L 2x 16L	400 mm	901239104

## CUBOS DE BASURA ECOLÓGICOS



Cubetas	Volumen	Ancho	Cubo ecológico
1	1x 34L	400 mm	90123E1
2	2x 16L	400 mm	90123E2 *con freno
3	1x 16L y 2x 8L	400 mm	90123E3C

Cubetas	Volumen	Ancho	Cubo ecológico
1	1x 16 L	350 mm	90123A



## CUBO DE BASURA ECOLÓGICO PARA CACEROLERO



600 mm

800 mm

900 mm

Cubetas	Volumen	Ancho	Ecológico cacerolero
3	1x 16L y 2x 8L	450-500	90123C50
3	2x 16L, 1x 8L y 1 bandeja	600 mm	90123C60
4	2x 16L, 2x 8L y 2 bandejas	700- 800	90123C80
4	3x 16L, 2x 8L y 2 bandejas	900 mm	90123C90
6	4x 16L, 2x 8L y 2 bandejas	1200 mm	90123C120



\* Altura 300 mm

Alambre  
Cestos

## CUBO ECOLÓGICO FIJACIÓN FRONTAL



Cubetas	Volumen	Ancho	Cubo ecológico
2	2x 16 L	400 mm	90123E2F

## CUBO APERTURA AUTOMÁTICA



Cubetas	Volumen	Ancho	Cubo ecológico
3	1x 34L y 2x 7L	600 mm	90123S603C
4	2x 15L y 2x 7L	600 mm	90123S604C



Acople perfil gola

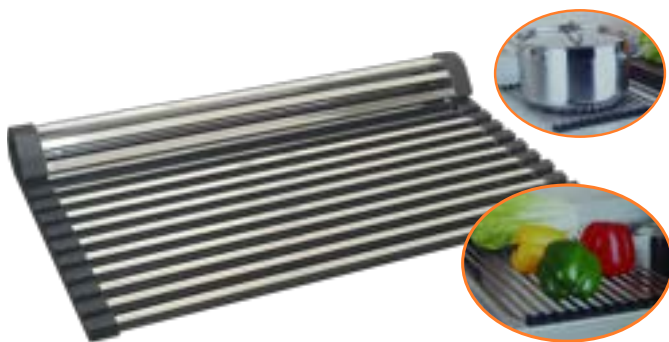
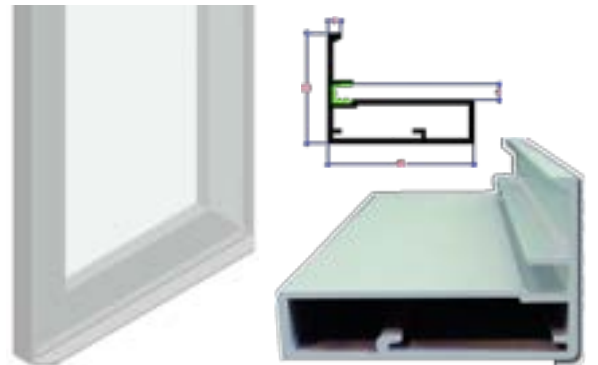
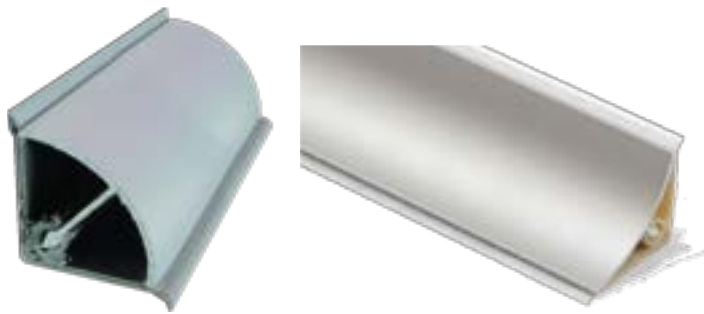

# ACCESORIOS PERFILES Y PATAS

	PÁGINA
Bisagras rincón .....	58
Bastidores .....	58
Marcos microondas .....	58
Protectores .....	58-59
Coperos, botelleros y colgadores .....	60
Perfilería para cristal .....	61
Perfil con goma .....	61
Vitrinas .....	62
Zócalos .....	63
Patas .....	64
Copetes y cantoneras encimera .....	65
Persianas .....	66
Salida de humo .....	67

## BISAGRA RINCÓN



Acople perfil gola

\* Consultar otras medidas y acabados.

La bisagra cuadrada incluye acoples para gola

Bisagra rincón	700 mm		800 mm		900 mm	
	Redonda	Cuadrada	Redonda	Cuadrada	Redonda	Cuadrada
Inox	80270IN	80270CIN	80280IN	80280CIN	80290IN	80290CIN
Aluminio	80270AL	80270CAL	80280AL	80280CAL	80290AL	80290CAL
Cromo brillo	80270CR	80270CCR	80280CR	80280CCR	80290CR	80290CCR
Blanco	80270BL	80270CBL	80280BL	80280CBL	80290BL	80290CBL
Oro viejo	80270OV	80270COV	80280OV	80280COV	80290OV	80290COV
Negro	80270NG	80270CNG	80280NG	80280CNG	80290NG	80290CNG
Haya	80270H	80270CH	80280H	80280CH	80290H	80290CH
Pino	80270PI	80270CPI	80280PI	80280CPI	80290PI	80290CPI
Roble	80270RB	80270CRB	80280RB	80280CRB	80290RB	80290CRB

## BASTIDOR PARA FREGADERO (REFUERZO DEL MUBLE)

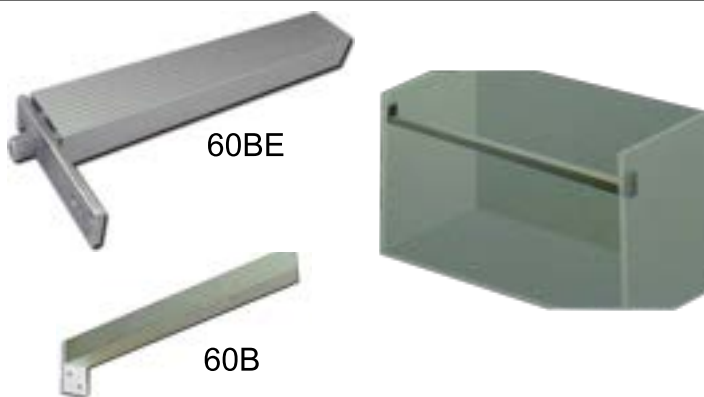

Bastidor	Aluminio	Medidas	Aluminio
3000 mm	60BAL	700 mm	60B70
450 mm	60B45	800 mm	60B80
500 mm	60B50	900 mm	60B90
550 mm	60B55	1000 mm	60B100
600 mm	60B60	1200 mm	60B120
Soportes	60BS		
Barra 3 metros bastidor extra			Aluminio
15x25 mm			60BE3
Soporte bastidor extra			60BSE

## PROTECTOR DE COSTADO



Medida	Acero	Plastico inox	Plástico mate
19 mm	60PC19A	60PIN	60PCCM
22 mm	60PC22A		

## PROTECTOR COSTADO ADHESIVO MULTIMEDIDA



\* Consultar acabados

\*\* Pata nivelador opcional

Acabado	16 mm	19 mm	21 mm	25 mm
Aluminio	60PCAD16AL	60PCAD19AL	60PCAD21AL	60PCAD25AL
Inox	60PCAD16IN	60PCAD19IN	60PCAD21IN	60PCAD25IN
Blanco	60PCAD16BL	60PCAD19BL	60PCAD21BL	60PCAD25BL

## BARRA ANTIPANDEO



Refuerzo antipandeo para muebles anchos	Aluminio
Barra de 3 metros	60BAP3
Soporte fijación central	60BAPSC
Soporte fijación	60BAPSF

## PROTECTOR DE HORNO



Acero	16 mm	19 mm
Protector "L"	6050016A	6050019A
Separador	6060116A	6060119A

# TUBO COLGADOR PARED



Terminador tubo    Soporte    Gancho    Tubo colgador

Accesorios tubo colgador	Cromo
Tubo 1m 16mmØ grosor 1.5mm	70165CR
Ganchos parra tubo	70161CR
Juego 2 tapones terminales tubo	70151CR
Juego soporte moderno (2 soportes)	70163CR

## SOPORTE TRIPLE



Medidas (mm)	Cromo
365x335x135	70723CRE

## ESPECIERO MULTIUSOS



Medidas (mm)	Cromo
310x350x150	70731ECR

## ESCURREPLATOS



Medidas (mm)	Cromo
250x450x280	70773CR

Accesorios  
Perfiles y Patas

## PROTECTOR ESTERILLA



Protector esterilla encimeras	Cromo
497x545x15 mm (18 barras)	60PEAIN5054

## BARRAS PROTECTORAS



Protector esterilla encimeras	Inox
Barras adhesivas (6 barras)	60BP

## MARCO MICROONDAS



Marco microondas	600x40 mm
Inox	MMX
Blanco	MM10
Negro	MM19

## PLACA PROTECTORA



Salva encimeras	Inox
Plancha 315x400 mm	60SE

## CUBRE PLACA



Cubre Placas	Cromo	Blanco
Encimera de gas 60x52x5	60CE	
Encimera de gas 60x52x5		60CEBL
Encimera de vitro 60x52x3	60CEV	

## SOPORTE TECHO



Soporte techo balda cromado	
Varilla 950 mm	80100STCR

# ACCESORIOS DE COCINA

## SOPORTE COPAS



Fijación lateral y/o superior

Fijación lateral y/o superior	Cromo
5 filas 453x320x71 mm	70SCCRE

## SOPORTE COPAS

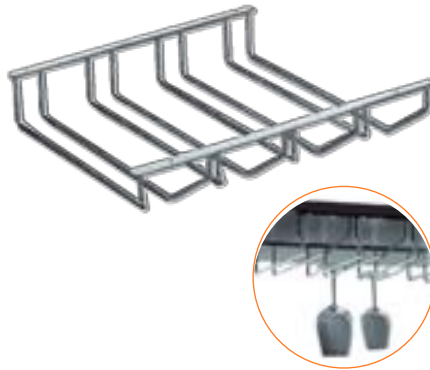

Fijación superior

Fijación superior	Cromo
4 Filas 405x342x64 mm	70SCCR

## SOPORTE COPAS



Atornillar lateral o superior	Cromo
1 Fila 107x340x65 mm	70SC1CR

## BOTELLERO SOBRE ENCIMERA



Sobre encimera cogida lateral	Cromo
Botellero 4 pisos 12 botellas	B12CR

## BOTELLERO CON BASE



Sobre encimera con base	Cromo
6 botellas 250x630 mm	70BSE

## BOTELLERO LATERAL/SUPERIOR



Atornillar lateral o superior	Cromo
6 botellas 660x175x115	70BP6CR

## PROTECTOR DE CAMPANA

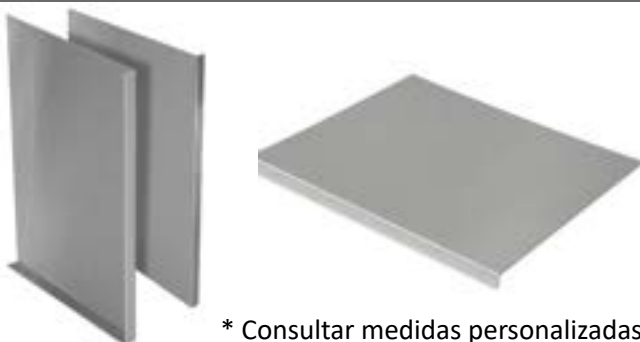

\* Consultar medidas personalizadas

Juego lateral campana	Inox	Blanco
330x270 mm	603327IN	603327BL
350x270 mm	603527IN	603527BL
700x330 mm	603370IN	603370BL
900x330 mm	603390	603390BL

## COLGADOR DE PAÑOS



Cuelga paños	Cromo
400x600 mm (5 Ganchos)	90P5GCR

## PERFIL " T " CANTO DE PUERTA

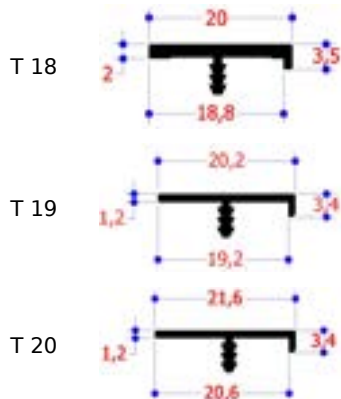

\* Referencias por metro de tira  
\*\* Consultar disponibilidad

Acabado	18 mm	19 mm	20 mm
Aluminio	60T18	60T19	60T20
Cromo brillo	60T18CR	60T19CR	60T20CR

## PERFIL SUPERIOR

\* Incluye goma antigolpes

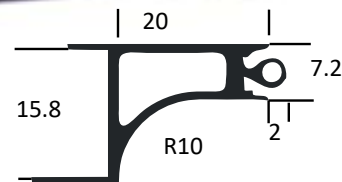

\* Consultar medidas cortadas

Barras de 3 metros	Inox	Cromo mate	Blanco	Negro
16 mm con Goma	4487300IN	4487300CM	4487300BLT	4487300NG

## PERFIL "U" CURVO

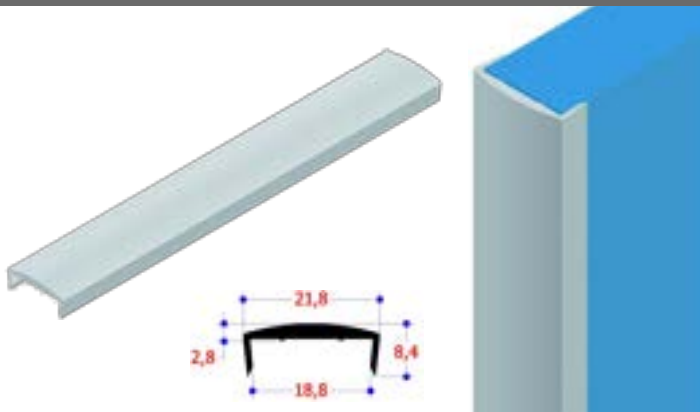

Acabado	19 mm
Aluminio	60U197AL
Cromo brillo	60U197CR

## PERFIL "U" RECTO

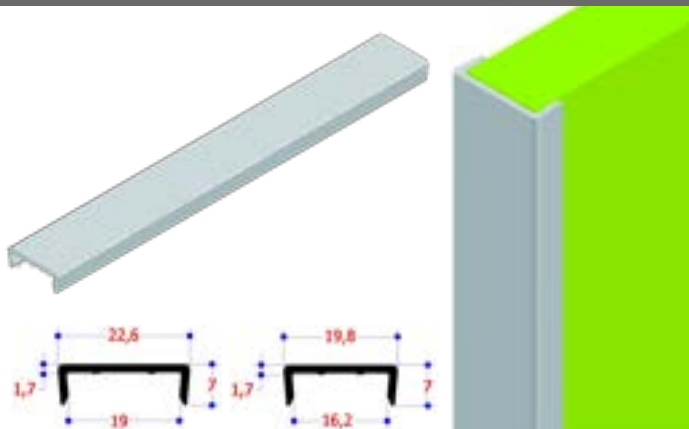

Acabado	16 MM	19 mm
Aluminio	60U167AL	60U197RAL
Cromo brillo	60U167CR	60U197RCR

## PERFIL CRISTALERA

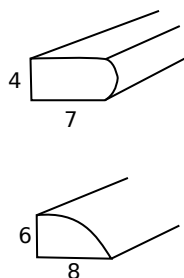

Perfil por metros	6x8 mm	7x4 mm
Blanco	5052610	
Roble Claro	50526R	50525R
Roble oscuro	50526N	

## PERFIL CRISTALERA ADHESIVO



Tiras de 3000 mm	Perfil	Esquinas
Blanco	30800BL	30801BL
Cromo mate	30800CM	30801CM
Cromo brillo	30800CR	30801CR

Accesorios  
Perfiles y Patas

# PERFILES VITRINAS

## MODELO "A"

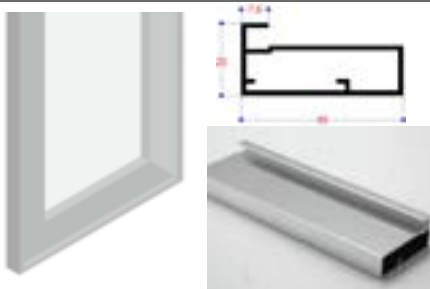

Cristal 4 o 3 mm Bisagras Ø35 y 26 mm

Cromo mate	Cromo brillo	Inox
Blanco	Negro	Antracita

## MODELO "AT"

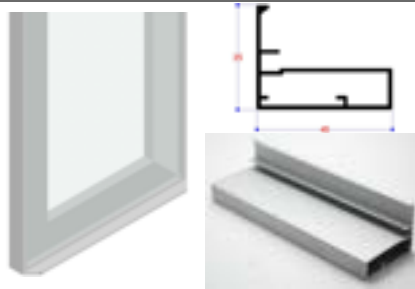

Cristal 4 o 3 mm Bisagras Ø35 y 26 mm

Cromo mate	Cromo brillo	Inox
Blanco	Negro	Antracita

## MODELO "G"

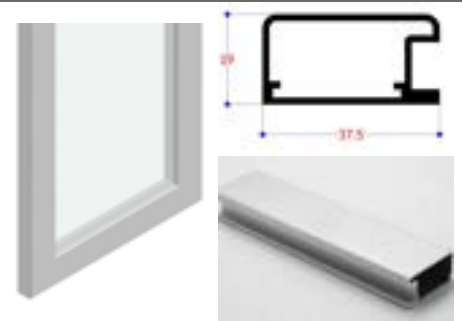

Cristal 4 mm Bisagras Ø26

Cromo mate

## MODELO "O"

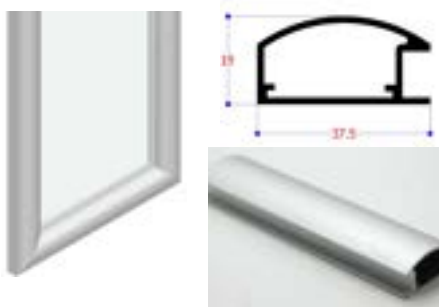

Cristal 4 mm Bisagras Ø26

Cromo mate

## MODELO "M"

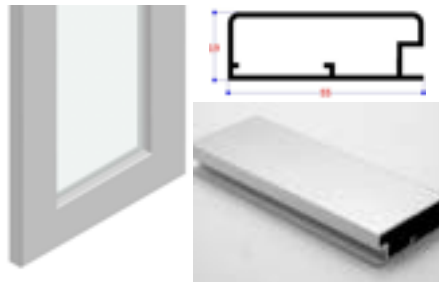

Cristal 4 mm Bisagras Ø35 y 26 mm

Cromo mate	Inox
Cromo brillo	Antracita

## MODELO "L"

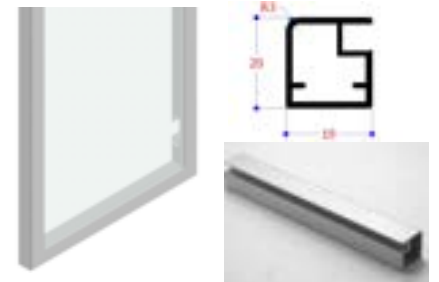

Cristal 4 o 3 mm Bisagras para perfil

Cromo mate	Cromo brillo	Inox
Blanco	Negro	Antracita

## MODELO "D"

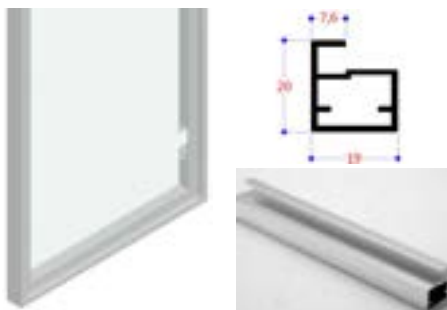

Cristal 4 o 3 mm Bisagras para perfil

Cromo mate	Cromo brillo
------------	--------------

## MODELO "K"

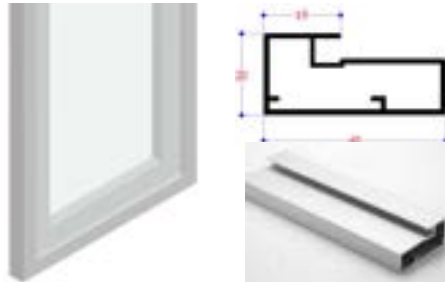

Cristal 4 mm Bisagras Ø35 y 26 mm

Cromo mate	Cobre anodizado
Blanco	Negro

## MODELO "Z"

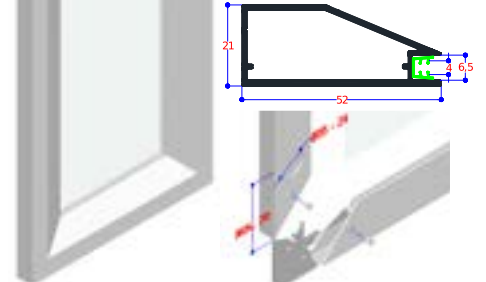

Cristal 4 mm Bisagras Ø35 y 26 mm

Cromo mate	Cobre anodizado
Blanco	Negro

## PERFIL "H" TRAVESAÑO

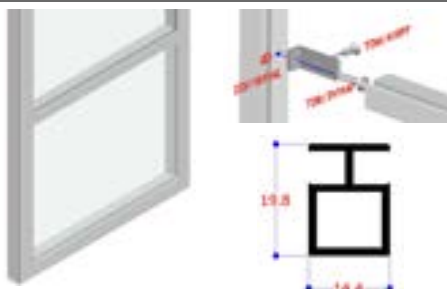

Cristal 4 mm acabado cromo mate

Modelo "A"	Modelo "L"
Modelo "D"	Modelo "K"

## SISTEMA PUERTAS PLEGABLES



Sistema puertas plegables

Ángulo 15x15 mm	40APP
Jgo herrajes / puerta	40HPP

## SISTEMA PUERTAS CORREDERAS



\* Cualquier modelo de perfil Aluminio y Madera

Sistema puertas correderas

Guía corredera 3 metros	40GC
Jgo herrajes / puerta	40HC

\* Indicar modelo + alto + ancho + (posición del tirador si lo lleva) + (posición mecanizado si lo lleva)



## ZÓCALOS DE PVC ALUMINIO Y/O ALUMINIO MACIZO

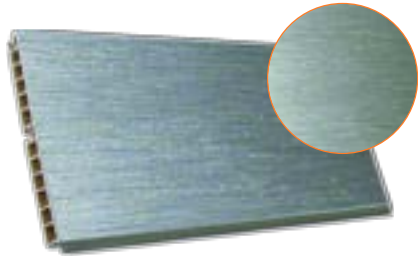

ZÓCALO PVC ALUMINIO

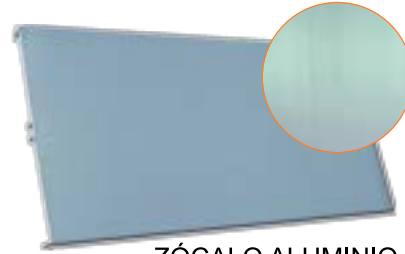

ZÓCALO ALUMINIO MACIZO

\* Consultar por encargo



Altura	PVC ALUMINIO			Esquina reversible PVC			ALUMINIO MACIZO		Esquina reversible	
	Aluminio	Blanco	Negro	Aluminio	Blanco	Negro	Aluminio	Blanco	Aluminio	
10 mm	50210IN	50210BL	50210NG	50202REIN10	50202REBL10	50202RNG10	40510CR	40510BL*	40511CR	*
14.5 mm	50214IN	5021410	5021419	50202RIN	50202RBL	50202RNG	40514CM	40514BL*	40515CM	*
17 mm	50217IN						40516CR *		40517CR	*

## PINZAS DE ZÓCALO

## PATAS DE MUEBLE



Madera



PVC



Aluminio



Accesorios  
Perfiles y Patas

	PVC	PVC y Aluminio	Madera
Pinzas zócalo	50505	50501	50501T

Altura	Montaje directo	Hulk	Tuerca marrón	Tuerca blanca
10 mm	50540D10	50540H10E		5054010DTBL
15 mm	50540D	50540HE	50540DT22	50540DT

## BANCADA ALUMINIO

## PROTECTOR ZÓCALO



Bancada de aluminio		
Con patas regulable *indicar medidas		40BAP
Con ruedas *indicar medidas		40BAR

Acabado	Transparente	Blanco	Roble
16 mm	5052030	50520B	50520R
19 mm	5052130	5052110	50521R
21 mm	50522TR	50522BL	50522R

# PATAS DE MUEBLE

## PATAS PENÍNSULA



\* Las medidas pueden variar, consultar

Forma	Redonda Ø 60mm					Cuadrada 60x60mm			
	Cr. brillo	Aluminio	Inox.	Blanca	Negra	Aluminio	Inox	Blanca	Negra
73mm		50400CRM	50400IN	5040010	5040019	50420CM	50420IN	50420BL	50420NG
83mm	50401C	50401CRM	50401IN	5040110	5040119	50421CM	50421IN	50421BL	50421NG
85mm		50402CRM							
87mm			50402IN	50422BL			50422IN	50420BL	50422NG
105mm		50404CM				50424CM			

## PATA OBLÍCUA



Altura	Inox	Cr. Brillo	Cr mate
200 mm	50570IN	50570CR	50570AL

## PATA REDONDA REGULABLE



Regulable	Medidas	Inox
150 mm	Ø 50 mm	50544INE

## PATAS CÓNICAS REGULABLES



Regulable	100 mm	150 mm	Regulable	Cr. Brillo
Inox	50543IN10	5054315IN	100 mm	50545CR

## PATAS CUADRADAS ALUMINIO NEGRO



\* Consultar medidas y acabados

Medidas	Negro	Medidas	Negro
H10 4x1	5054910NG	H10 8x8	5054910NG
H15 5x1	5054915NG	H15 8x8	5054915NG

## PATAS CUADRADAS REGULABLES



Regulable	Inox	Regulable	Aluminio
100x25x25 mm	5054710IN	100x40x40 mm	50572AL
150x25x25 mm	5054715IN	150x40x40 mm	50548AL
200x25x25 mm	5054720IN	200x40x40 mm	5054820AL

## PATA REDONDA REGULABLE



Regulable	Aluminio	Regulable	Inox
100 mm x Ø 40 mm	5054410AL	100 mm x Ø 30 mm	5054610IN
150 mm x Ø 40 mm	505441TALL		

## COPETE SUPERIOR



\* Consultar acabados por encargo



4 m.	Copete	Rincón	Esquina	Tapa izq	Tapa dcha
Brillo	40410CR4	40411CR	40412CR	40413CR	40414CR
Mate	40410CM4	40411CM	40412CM	40413CM	40414CM
Blanco	40410104	4041110	4041210	4041310	4041410
Negro	4041019	4041119	4041219	4041319	4041419
Bronce	40410BC	40411BC	40412BC	40413BC	40414BC

## COPETE ESCUADRA



\* Consultar acabados por encargo



4000 mm	Copete	Rincón	Esquina	Tapas
Cr brillo	40420CR	40421CR	40422CR	40423CR
Cr mate	40420CM	40421CM	40422CM	40423CM
Blanco	40420BL	40421BL	40422BL	40423BL
Negro	40420NG	40421NG	40422NG	40423NG
Bronce	40420BC	40421BC	40422BC	40423BC

## COPETE CONVEXO



\* Consultar acabados por encargo



4000 mm	Copete	Rincón	Esquina	Tapas
Cr brillo	40415B	40416B	40417B	40418B
Cr mate	40415CR	40416 CR	40417 CR	40418 CR
Blanco	40415BL	40416BL	40417BL	40418BL
Negro	40415NG	40416NG	40417NG	40418NG
Bronce	40415BC	40416BC	40417BC	40418BC

## COPETE CONCAVO



\* Consultar acabados por encargo

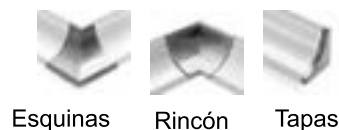

4000 mm	Copete	Rincón	Esquina	Tapas
Cr brillo	40440CR	40441CR	40442CR	40443CR
Cr mate	40440CM	40441CM	40442CM	40443CM
Blanco	40440BL	40441BL	40442BL	40443BL
Negro	40440NG	40441NG	40442NG	40443NG
Bronce	40440BC	40441BC	40442BC	40443BC

## COPETE PLANO



\* Consultar acabados por encargo



4000 mm	Copete	Rincón	Esquina	Tapas
Cr brillo	40450CR	40451CR	40452CR	40453CR
Cr mate	40450CM	40451CM	40452CM	40453CM
Blanco	40450BL	40451BL	40452BL	40453BL
Negro	40450NG	40451NG	40452NG	40453NG
Bronce	40450BC	40451BC	40452BC	40453BC

## UNIÓN ENCIMERA OCULTA



Unión encimera oculta con rosca

6x100 mm

90PUE6100

## TAPA Y UNIÓN ENCIMERA 30 mm FORMA CURVA



\* Consultar acabados por encargo

30 mm	Tapa	Unión	Angular doble
Cr brillo	40430L	40432L	40431L
Cr mate	40430CR	40432CR	40431CR
Blanco	40430BL	40432BL	40431BL
Negro	40430NG	40432NG	40431NG

## TAPA Y UNIÓN ENCIMERA 40 mm FORMA RECTA



\* Consultar acabados por encargo

40 mm	Tapa	Unión	Angular doble
Cr brillo	40430HCR	40432HCR	40431HCR
Cr mate	40430HCM	40432HCM	40431HCM
Blanco	40430HBL	40432HBL	40431HBL
Negro	40430HNG	40432HNG	40431HNG

# PERSIANAS

## PERSIANAS DE CRISTAL



### Acabados

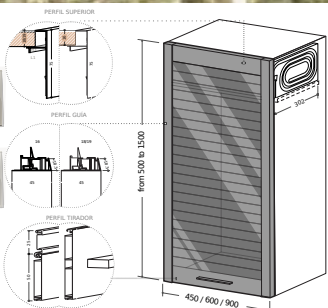
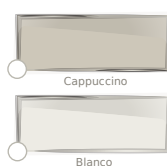

Anchura	450 mm	600 mm	900 mm
Transparente	70KP450CRTR	70KP600CRTR	70KP900CRTR
Ácido	70KP450CRAC	70KP600CRAC	70KP900CRAC
Negro	70KP450CRNG	70KP600CRNG	70KP900CRNG
Blanco	70KP450CRBL	70KP600CRBL	70KP900CRBL
Capuccino	70KP450CRCP	70KP600CRCP	70KP900CRCP

## PERSIANAS DE PVC



\* Consultar otras medidas y acabados\*\* Las lamas se pueden cortar para medidas especiales. MEDIDAS TAMBUCHO: Fondo: 280 mm Alto: 200 mm

Acabados	150x60 mm	150x90 mm
Inox	70KPPVC15060IN	70KPPVC15090IN
Blanco brillo	70KPPVC15060BB	70KPPVC15090BB
Blanco mate	70KPPVC15060BL	70KPPVC15090BL
Carbono (antracita)	70KPPVC15060CA	70KPPVC15090CA
Imitación cristal	70KPPVC15060CR	70KPPVC15090CR
Negro mate	70KPPVC15060NG	70KPPVC15090NG
Multicantos	70KPPVC15060MC	70KPPVC15090MC

## PERSIANAS FENIX



Persianas Fenix

\* Consultar medidas y acabados.

## AUTOENROLLABLE CON LAMAS CIEGAS ALUMINIO



\* Consultar otras medidas y acabados

MEDIDAS TAMBUCHO:

Fondo: 280 mm  
Alto: 200 mm

Alto	Ancho	Aluminio	Inox	Antracita
70 mm	60 mm	70KP7060AL	70KP7060ALIN	70KP7060ALAN
90 mm	60 mm	70KP9060AL	70KP9060ALIN	70KP9060ALAN
120 mm	60 mm	70KP12060AL	70KP12060ALIN	70KP12060ALAN
147 mm	45 mm	70KP14745AL	70KP14745ALIN	70KP14745ALAN
147 mm	60 mm	70KP15060AL	70KP15060ALIN	70KP15060ALAN
147 mm	90 mm	70KP14790AL	70KP14790ALIN	70KP14790ALAN

## TUBO PVC EXTRACCIÓN



Sección redonda	Tubos 1,5 metros	Sección Rectangular	Tubos 1,5 metros
100 mm	90113	55x110 mm	90114
120 mm	9011312	70x147 mm	9011414
150 mm	9011315	90x170 mm	9011417

## EMPALME PVC



Diametro	Redondo	Sección Rectangular	Rectangular	Mixto
100 mm	90124	55x110 mm	90114	90122
120 mm	9012412	70x147 mm	9011414	9012212
150 mm	9012415	90x170 mm	9011417	9012215

## CODOS PVC

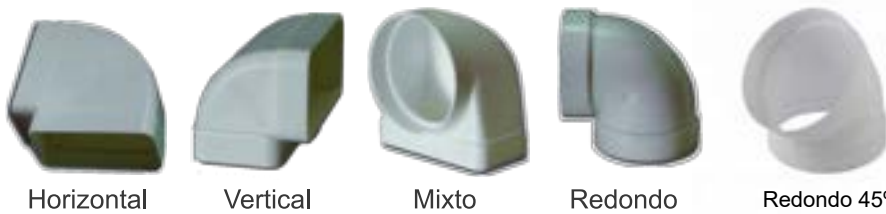

Sección	Horizontal	Vertical	Mixto	∅	Redondo
55x110	90115	90117	90119	100	90127
70x147	9011514	9011714	9011912	120	9012712
90x170	9011517	9011717	9011915	150	9012715

## EMPALME REDUCTOR



∅	Redondo 45°	Sección	Redondo
100	90136	120 a 100 mm	90121
120	90176	150 a 120 mm	901211512

## ABRAZADERAS



Diametro	Redondo	Sección Rectangular	Rectangular
100 mm	90135	55x110 mm	90134
120 mm	90113A12	70x147 mm	90112A14

## TUBO FLEXIBLE



Sección	Redondo
3 metros (102 mm)	90102
6 metros (127 mm)	9011276

## REMATE PARED



Diametro	Redondo	Sección Rectangular	Rectangular
100 mm	90131	55x110 mm	90116
120 mm	9013112	70x147 mm	90116147

## VENTANA SALIDA



Diametro	Redondo	Sección Rectangular	Rectangular
100 mm	90133	55x110 mm	90132
120 mm	9013312	70x147 mm	9013214
150 mm	901371517	90x170 mm	901371517



Soportes y baldas  
Soportes y patas  
Mesas y estructuras



70-72  
73-74  
75

# SOportes ESCUADRAS

xxx

# SOPORTES PARA BALDA

## SOPORTE CUADRADO

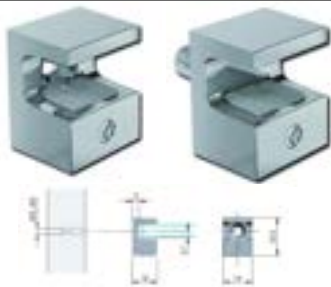

Soporte balda	Cromo
Con pivote 5 mm	80115PCR
Sin taladro	80115CR

## SOPORTES REDONDO



Soporte balda	Niquel mate
Con pivote 5 mm	80103CPPNM

## SOPORTES CON GOMA



Soporte balda	Niquel mate
Con pivote 5 mm	80117

## SOPORTE CON VENTOSA

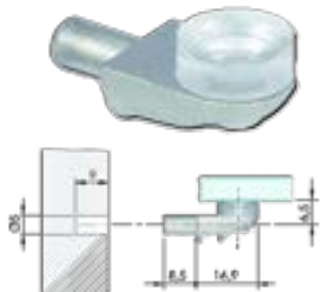

Soporte balda	Niquel mate
Con ventosa	80116

## SOPORTE OCULTO



Soporte kerala	Metálico
Soporte 3 mm	80507
Embellecedor blanco	80508

## SOPORTE OCULTO



Soporte Maori	Cromo
Soporte balda oculto	80504CR

## SOPORTES BALDA



Soporte	Blanco	Cromo
Sop. Cristal	80150910	801509CR

## SOPORTES BALDA



Soporte balda	Plástico
Transp. nervio metal	805025TRM
Plástico blanco	8050210
Plástico marrón	80502R
Plástico transparente	805025TR

## SOPORTES BALDA



Soporte balda	Transparente
Plástico nervio metal	80501M30

## SOPORTE METÁLICO



Soporte balda	Cromo
Soporte entrepaño	80501M

## SOPORTE ROSCADO



Roscado	Blanco	Marrón
Grande	8050310	80503R
Pequeño	8050310P	80503RP

## SOPORTE DOS PUNTAS



Soporte	Blanco	Marrón
2 puntas	805032P10	805032P22



## SOPORTE ESTANTE

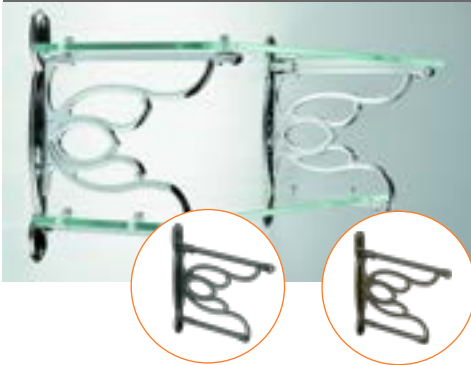

\*Kit para balda de cristal ancho 600mm

Acabado	Ref.
Oro viejo	80135OV
Plata vieja	80135PV
Kit cristal cromo	80135K60CR

## SOPORTE ESTANTE



Soporte	Oro viejo	Plata vieja
Escuadra	80134OV	80134PV

## ESCUADRA ABATIBLE



Soporte	30x30 (50 Kg)	40x40 (80Kg)
Escuadra	90130	90140

## SOPORTE ESTANTE



Escuadra	Cromo
250x200 mm	9012520

## SOPORTE ESTANTE



Escuadra	Inox
220x220 mm	9012222IN

## SOPORTE ESTANTE



Escuadra con percha	Inox
250x200 mm	9012520IN

Soportes y Escuadras

## SOPORTE ESTANTE



Escuadra	Blanca
250x300 mm	9012530BL
150x120 mm	9012515BL

## SOPORTE ESTANTE



Soporte estante	Metal
Soporte oculto	80112

## SOPORTE ESTANTE

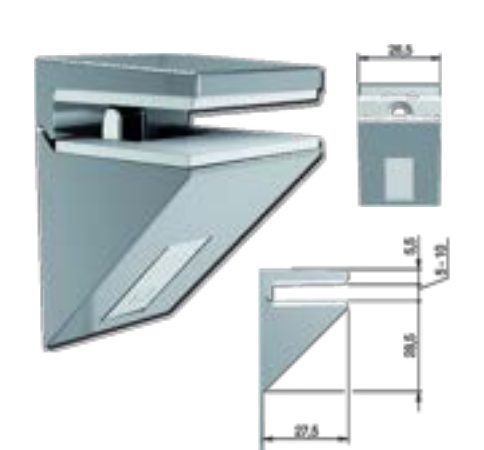

Soporte	Cromo	Inox
Mini	80104KMCM	80104KMIN

# SOPORTE DE ESTANTE

## SOPORTE BALDA

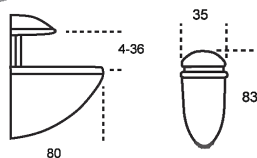

Apertura	36 mm
Inox	80100EIN
Cromo mate	80100ECM

## SOPORTE BALDA



Apertura	30 mm
Inox 65x75 mm	80100MNM

## SOPORTE BALDA



Apertura	22 mm
Inox 55X55 mm	80100EPNM

## SOPORTE BALDA

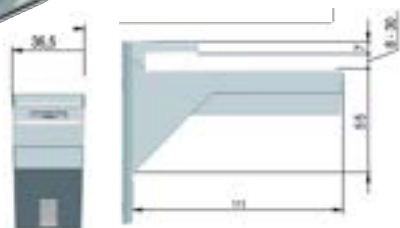

Apertura	Cromo	Inox
30 mm	80104KCM	80104KIN

## SOPORTE BALDA

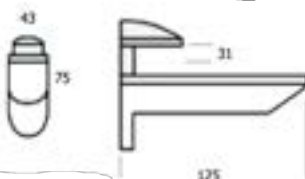
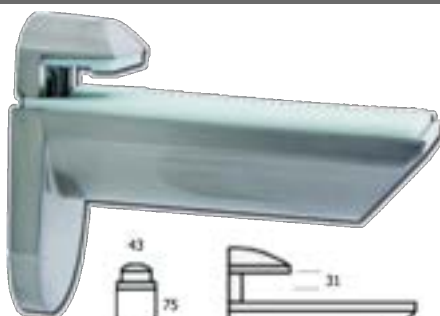

Apertura	31 mm
Cromo	80110CM
Inox	80110IN
Bronce	80110BC

## SOPORTE BALDA

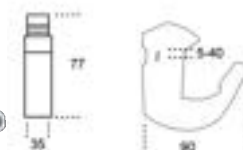

Apertura	40 mm
Cromo mate	80113MCM

## SOPORTE BALDA

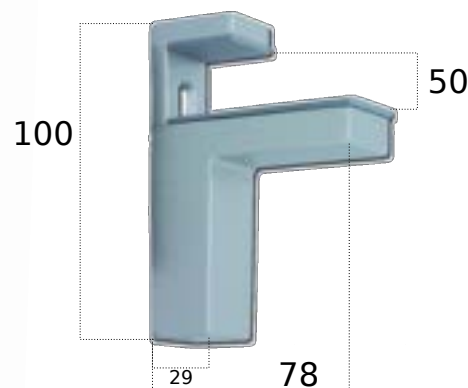

Apertura	50 mm
Cromo mate	80105CM
Negro	80105NG
Blanco	80105BL

## SOPORTE TELEVISIÓN



## SOPORTE MICROONDAS



Soporte Giratorio max 35 Kg.	
Soporte TV (32"-55") VESA.	90129

Juego Soporte Microondas	
Gris	90128G
Blanco	90128

## MESA ELEVABLE MOTORIZADA HETTICH



Soportes y Escudras

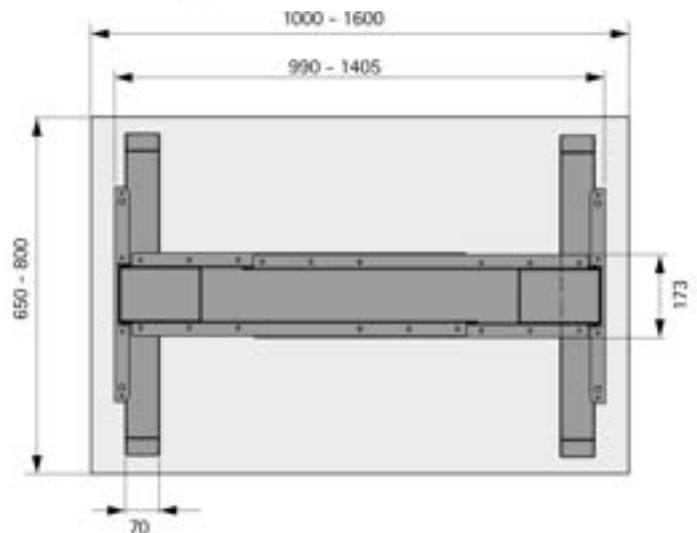
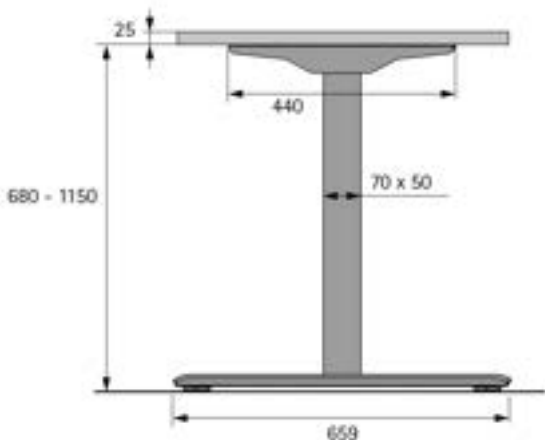

Acabados	Aluminio	Negro	Blanco
Mesa elevable 680-1150	90H9277885	90H9277886	90H9277887

## MESA EXTRAIBLE CON PATA



\* Soporta cargas de 100 Kg  
guías telescópica con patas

Altura min 120 mm y profundidad 540mm

Inox/Blanco módulo de 900 mm

MEP100

## MESA EXTRAIBLE SIN PATA



\* Soporta cargas de 30 Kg extracción 895 mm

Ancho max 900 extracción máxima 810

Inox/Blanco módulo de 900 mm

ME30



## MESA EXTRAIBLE ABATIBLE



Medidas Mesa

1270 320

Guías de 400 mm.

min. 510

Mesa extraible abatible para fente de 150 mm

Dimensiones 1270x320 mm

MEA15

## ESTRUCTURAS Y PATAS PARA TABLEROS DE MESA INDUSTRIAL

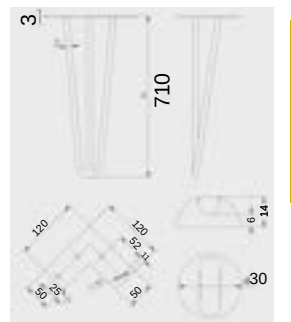
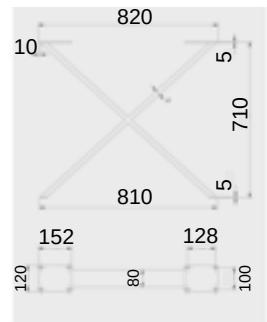
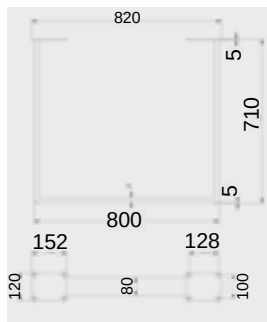
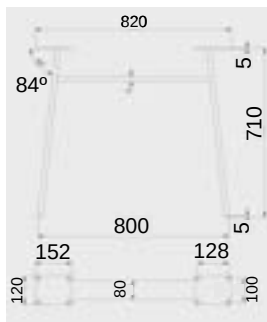
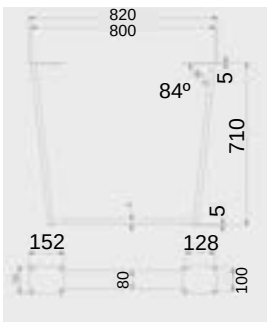

Soportes y Escuadras

Pata en V  
50427NG

Pata en H  
50429NG

Pata en U  
50426NG

Pata en X  
50428NG

\* Consultar otras medidas  
Patas 3 varillas  
50425NG

\* Consultar otras medidas y grosores

### ESTRUCTURAS MODULARES PERFIL 20X20



Estructura modular para estanterías y patas  
Perfilería en negro Especificar dimensiones y número de módulos

### ESTRUCTURAS MODULARES PERFIL 60X10



\* Consultar otras medidas y grosores

Estructura modular para estanterías y patas  
Varios acabados Especificar dimensiones y número de módulos

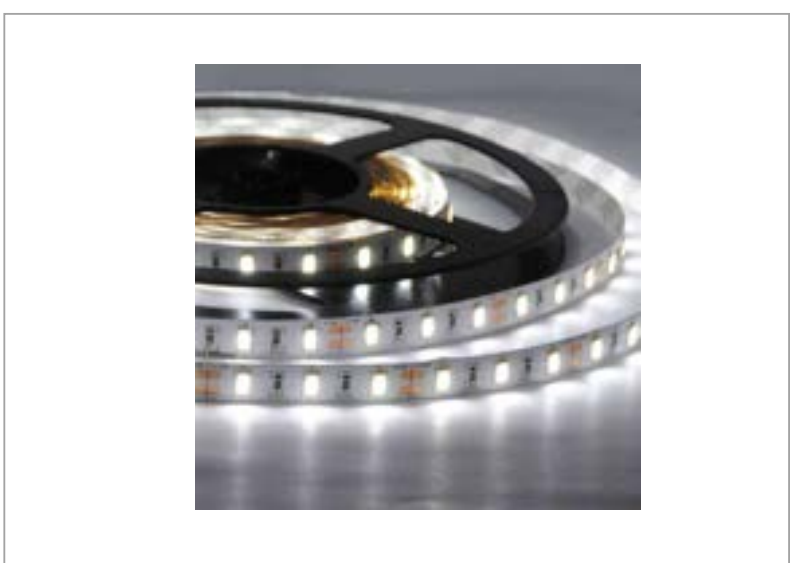

**Iluminación**  
**Enchufes**

.....  
.....

**PÁGINA**

**78-81**

**82-87**

# **ILUMINACIÓN ELECTRICIDAD**

## FOCO LED SUPERFICIE SERIE POLAR



materiales  
aluminio, policarbonato

Fuente de luz  
Módulo LGP LED

poder  
5W

fuelle de alimentación  
24Vdc

cable  
79" (2000mm)

Tipo de aplicación  
Superficie

instalación  
bajo gabinete, bajo estante

Permite encendido de los focos  
desde un solo foco (master)

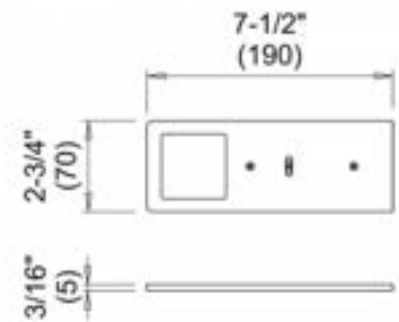

Acabado	Master	Slave
Plata	FL23AL	FL24AL
Antracita	FL23ALNG	FL24ALNG

## TRANSFORMADOR 24V CONEXION MICRO 24

entrada  
230Vac

salida  
24Vdc

poder  
254

Sistema de conexión  
Micro24

Cableado de entrada  
Cable de alimentación de  
2000mm con Europlug

Cableado de salida  
Cable de 500 mm con distribuidor  
hembra Micro24 de 9 vías



## SENSOR PROXIMIDAD O INTERRUPTOR TOUCHLES ENCASTRE Y/O SUPERFICIE



En el modo limit-switch, enciende y  
apaga la luminaria conectada a ella  
cuando la puerta está abierta o  
cerrada.

La configuración se puede cambiar del  
modo de interruptor de límite al  
modo de interruptor de atenuación de  
encendido/apagado, pulsando el  
botón en la parte posterior del  
dispositivo

### Transformadores

Transformador Mini (Plano)

TL15

### Sensor de encendido luminaria on/off y proximidad

Sensor de encendido luminaria

SLND



## PERFILERIA ALUMINIO LED



\* Consultar medidas y acabados

PERFIL DE ENCASTRE 3 METROS



\* Consultar medidas y acabados

PERFIL DE ESQUINA 2 METROS



\* Consultar medidas y acabados

PERFIL DE SUPERFICIE 2 METROS

Perfil 2000 mm	Encastrar	Encastrar Angular	Esquina	Superficie
Aluminio	FPEL2MAL	FPEAL2MAL	FPEEL2MAL	FPSL2MAL
Tapa PVC	FTPD2M	FTPD2M	FTPD2M	FTPDS2M
Terminador	FTP	FTP	FTPE	FTPS

## ROLLOS DE LED LUZ FRÍA CALIDA Y RGB



Conector rollo de led



Rollos de led con silicona IP65 (resistente a la humedad).  
30 Leds por metros. Incluye transformador.

Iluminación  
Electricidad

Longitud	Fria 6000K	Calida 3000K	Color RGB	Conector
1 metro	FR1LABL			CRL
2 metros	FR2LABL			
5 metros	FR5LABLF	FR5LABL	FR5LAMC	

## KIT 3 REGLETAS RÍGIDAS ROTABLES LED CON ACCESORIOS PARA ATORNILLAR



Incluye 3 regletas de 20 leds, soportes, conectores transformador e interruptor.

- Disponible en luz fría y cálida.
- Compatible con sensor.
- Medidas: 300x50 mm
- Potencia: 3x1.8W

Luz Fría	Luz Cálida
FK3RRF	FK3RRC

## TRANSFORMADOR LED



Transformadores
Transformador Led
TL

## LAMPARA LED CON BATERÍA RECARGABLE USB FIJACIÓN MAGNÉTICA



### Interruptor contactless

- Se acciona con mano ON/OFF
- Batería 1200 mAh.
- 200 - 280 lumens.
- Medidas de 400-600 mm.

### Sensor de presencia

- Se acciona con la presencia a 3 metros.
- Apagado a los 15-20 seg.
- Batería de 1250 mAh (10-12 horas).
- 100 lumens.

### Sensor de movimiento

- Encendido liberando sensor (abrir puerta/cajón).
- Apagado tapando sensor (cerrando puerta/cajón).
- Batería 1200 mAh.
- 200 - 280 lumens.
- Medidas de 400-600 mm.

Medida	Lumens	Interruptor contactless	Sensor de movimiento	Sensor de presencia
400 mm	200 lumens	FRL30CM	FRL31CM	FRL32CM
600 mm	280 lumens	FRL3060CM	FRL3160CM	

## BARRA LED OVAL ARMARIOS



Barra de armario oval LED con sensor

800 mm

FBAL100SCM

## BARRA LED REDONDA ARMARIOS



Barra de armario LED con sensor

800 mm

FBAL80SLCM

## LUZ BISAGRA CON SENSOR



Clip LED con sensor de movimiento

Luz fria

FLB

## KIT 3 FOCOS LED DE SUPERFICIE O ENCASTRE



Encastre

Superficie en blanco

Ø 35	Blanco encastre o superficie	Plata
Encastre	FK3L35BLOC*	FK3L35BLOF

## KIT 3 FOCOS LED ENCASTRE DIRECTOS 220V CUADRADOS



Medidas: 70x70 mm  
Potencia 3x1.2 W  
Mínimo encastre 19 mm  
No necesita transformador  
Acabado Inox

## KIT 3 FOCOS LED ENCASTRE DIRECTOS 220V REDONDOS



Medidas: 70x70 mm  
Potencia 3x1.2 W  
Mínimo encastre 19 mm  
No necesita transformador  
Acabado Inox

### Kit 3 focos cuadrados 220V

Luz Fría	FKLCF3IN
Luz Cálida	FKLCC3IN

### Kit 3 focos redondo 220V

Luz Fría	FKLF3IN
Luz Cálida	FKLC3IN

## KIT 3 FOCOS LED ALUMINIO CON TRANSFORMADOR



Diametro: 56mm  
Grosor: 7 mm  
Potencia 3x2 W  
Kit compatible sensor  
Luz Fría

## KIT 4 FOCOS LED TULIPA OPAL

Diametro: 58mm  
Grosor: 7 mm  
Potencia 4x1.2 W  
Kit compatible sensor  
9 LED Luz Cálida



### Kit 3 focos LED aluminio

Luz Fría	FK3LAL
----------	--------

### Kit 4 focos LED Tulipa opal

Luz Cálida	FK4LCM
------------	--------

## KIT 3 FOCOS LED CROMO MATE CON TULIPA OPAL

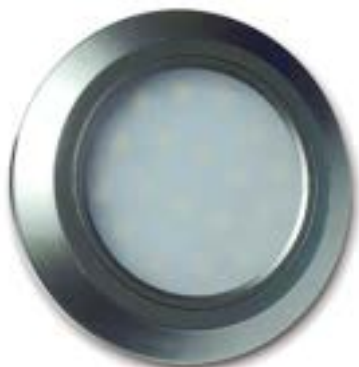

Medida: 120x120 mm  
Potencia 2x3.3W  
Compatible sensor

Incluye:  
- Cables e interruptor  
- Transoformador

## KIT 2 TRIANGULOS LED

Medida: 120x120 mm  
Potencia 2x3.3W  
Compatible sensor  
Luz Cálida  
Incluye:  
- Cables e interruptor  
- Transoformador



### Kit 3 Focos Tulipa oval Cromo mate

Luz Fría	FK3LCMOF
Luz Cálida	FK3LCMOC

### Kit 2 Triangulares en acero

Luz Cálida	FKTL2
------------	-------

# ENCHUFES

## TWIST



Acabado	Shukos	USB	Ref
Inox	2	NO	EET
Inox USB	1	2	EETINUSB
Blanco brillo	2	NO	EETBL
Blanco mate	2	NO	EETBLM
Blanco mate USB	1	2	EETBLUSB
Negro brillo	2	NO	EETNG
Negro mate	2	No	EETNGM
Herramienta de montaje TWIST			EEHMT

Consultar otros acabados

## KAPSA



KAPSA 2m Cable (3 Slots)

KAPSA XS 2m Cable (2 Slots)

KAPSA XXS 2m Cable (1 Slots)



Shukos	USB	Aluminio	Blanco	Negro	Shukos	USB	Aluminio	Blanco	Negro	Shukos	USB	Aluminio	Blanco	Negro
3	NO	EEEKCM	EEEKBL	EEEKNG	2	NO	EEEK2CM	EEEK2BL	EEEK2NG	1	NO	EEEK1CM	EEEK1BL	EEEK1NG
2	2	EEEK22CM	EEEK22BL	EEEK22NG	1	2	EEEK12CM	EEEK12BL	EEEK12NG	NO	2	EEEK02CM	EEEK02BL	EEEK02NG

## DUE



\* Las medidas son aproximadas, no usar para cortes  
\*\* Consultar otros módulos

Enchufe DUE 2 shukos	
Blanco	EER2SBL
Negro	EER2SNG
Inox	EER2SIN

## V-DOCK (enchufe esquinero modular)

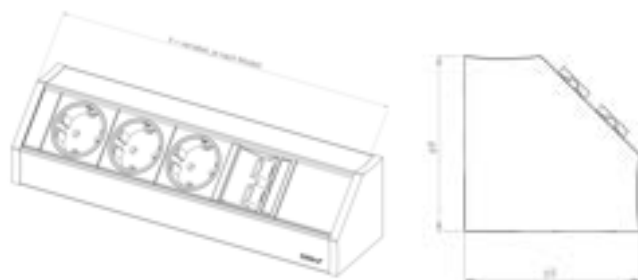

\* Las medidas son aproximadas, no usar para cortes  
 \*\* Consultar otros módulos

Acabado	Shukos	USB	REF
Negro	3		EQV3SUNG
Aluminio	3		EQV3SUAL
Negro	2	1	EQV2S1UNG
Aluminio	2	1	EQV2S1UAL

## V-PORT (enchufe esquinero deslizante con tapa)

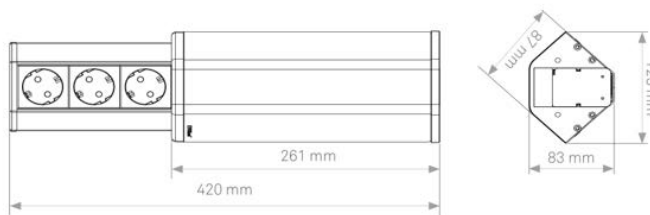

\* Las medidas son aproximadas, no usar para cortes  
 \*\* Consultar otros módulos

Acabado	Shukos	USB	REF
Negro/Inox	2	1	EQVP2S1UIN
Negro/Inox	3		EQVP3SIN

Iluminación  
Electricidad

## CASIA

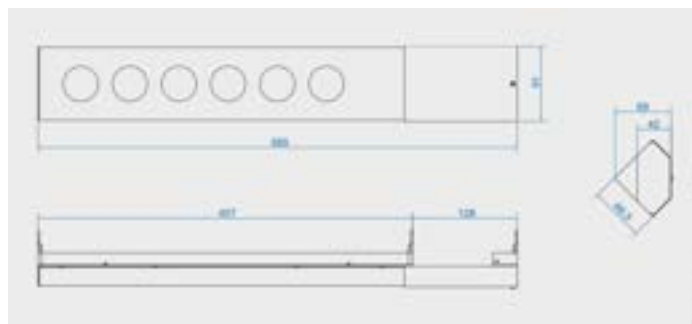

\* Las medidas son aproximadas, no usar para cortes  
 \*\* Consultar otros módulos

Interruptor	Shukos	USB	Ref
SI	4	No	EER4I
SI	4	2	EER4IUSB
No	4	No	EER4SIN

## ENCHUFE OVALADO

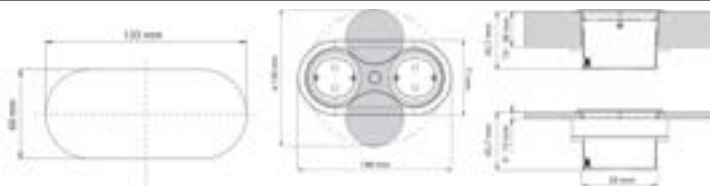

\* Las medidas son aproximadas, no usar para cortes



Enchufe ovalado inox tapa girable

Encastre 4 cm

EEOVIN

## PIX



\* Las medidas son aproximadas, no usar para cortes  
\*\* Consultar otros módulos

Enchufe encastrar PIX

Enchufe	EEPX	Cubierta negra	EEPCNG
Cubierta blanca	EEPCBL	Cubierta inox	EEPCIN

## ENCHUFE SLIM

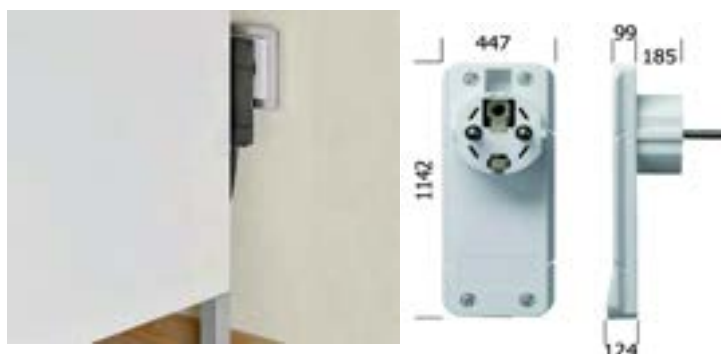

Enchufe ultrafino

Blanco	EUFBL
Negro	EUFNG

## CARGADOR QI INALAMBRICO



- Permite la carga rápida (9 V)
- Carcasa de aluminio de alta calidad
- Protección contra sobrecargas
- Instalación sencilla, sin herramientas

\* Las medidas son aproximadas, no usar para cortes  
 \*\* Consultar otros módulos

### Cargador Qi Inalambrico

Negro

EECMQI

## SQUARE (Cargador Qi con enchufe, usb y Red)

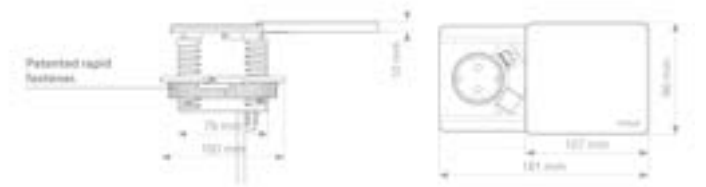
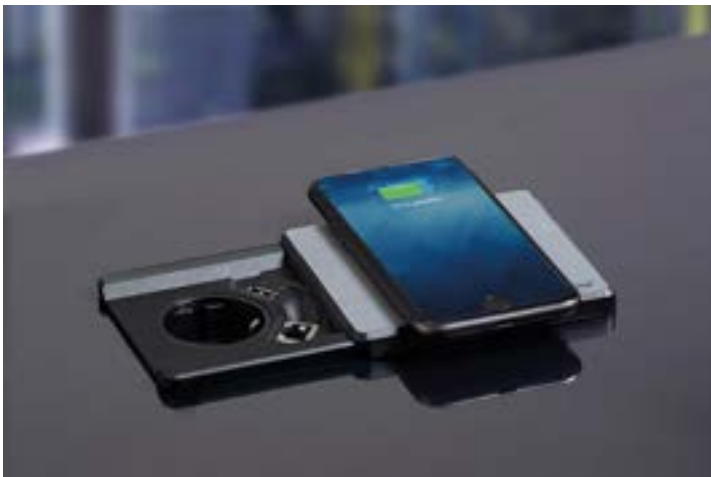

\* Las medidas son aproximadas, no usar para cortes  
 \*\* Consultar otros módulos

Acabado	Shukos	USB	REF
Inox	1	1	EEQI1S1UIN
Negro	1	1	EEQI1S1UNG
Blanco	1	1	EEQI1S1UBL

Iluminación  
Electricidad

## ENCHUFE EN CUÑA



### Enchufe en cuña inox

1 Shukos

LEN1

2 Shukos

LEN2

## LOOP IN



### Enchufe encastrar Loop In

Blanco  
Negro

EEPSCBL  
EEPSCNG

# ENCHUFES

## BACK FLIP ( Enchufe reversible con pulsador)

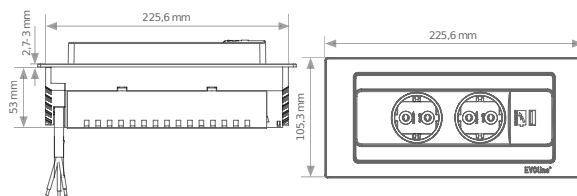

\* Las medidas son aproximadas, no usar para cortes

Acabado	Shukos	USB	REF
Inox	2	1	EEBF2S1UIN
Negro	2	1	EEBF2S1UNG
Blanco	2	1	EEBF2S1UBL
Cerámico	2	1	EEBF2S1UCC
Cristal negro	2	1	EEBF2S1UCRNG
Cristal blanco	2	1	EEBF2S1UCRBL

## ELEVATOR



Shukos	Shukos planos	USB	Ref.
1		2	EEE101USBIN
1	2		EEE10CM
2			EEE102IN

Consultar otros acabados



Tapa decorativa Elevator

Inox

EETRCIN



## PORT PUSH (Enchufe elevable modular)

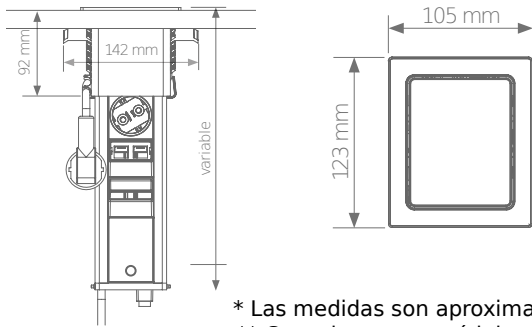

\* Las medidas son aproximadas.  
\*\* Consultar otros módulos



Acabado	Shukos	USB	REF
Inox	2	1	EEEEPP2S1UIN
Negro	2	1	EEEEPP2S1UNG
Blanco	2	1	EEEEPP2S1UBL
Cristal negro	2	1	EEEEPP2S1UCRNG
Cristal blanco	2	1	EEEEPP2S1UCRBL
Inox	3	-	EEEEPP3SIN
Negro	3	-	EEEEPP3SNG
Blanco	3	-	EEEEPP3SBL
Cristal negro	3	-	EEEEPP3SCRNG
Cristal blanco	3	-	EEEEPP3SCRBL

## UP ( Regleta fija vertical)

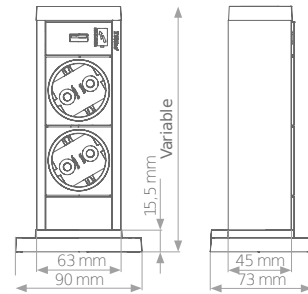

\* Las medidas son aproximadas, no usar para cortes

Acabado	Shukos	USB	REF
Inox	2	1	EEEE2S2UIN

Iluminación  
Electricidad

## ENCHUFE ENCASTRABLE EXTRAIBLE



Acabado	Shukos	USB	Ref.
Cromo mate	3	2	EEE2UCM

## ENCHUFE ESCAMOTEABLE 2 POSICIONES



Acabado	Shukos	USB	Ref.
Inox	3	2	EEE32USBIN
Negro	3	2	EEE32USBNG

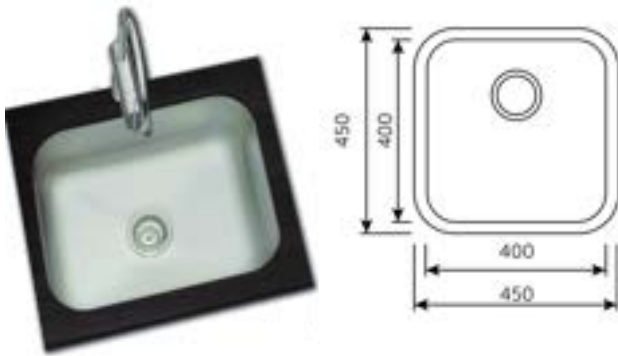
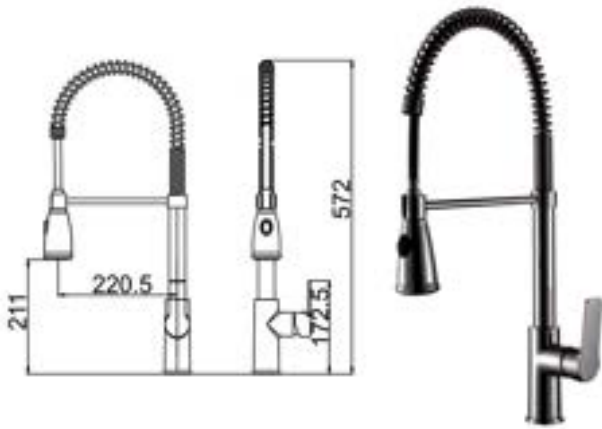

	PÁGINA
Fregaderos .....	90-92
Grifos .....	93

# FREGADEROS GRIFERÍA

# FREGADEROS DE ENCASTRE

## DISPENSADOR DE JABÓN



\* Todas las medidas son aproximadas, la empresa no se hace responsable del uso de estas medidas para encastrar.

Dispensador de jabón	Negro	Inox	Cromo brillo
Redondp 300 ml	90DDNG	90DDIN	90DD
Cuadrado 300 ml		90DDCIN	

## FREGADERO 1 SENO CUADRADO ENCASTRE



Fregadero 1 seno bajo encimera	Cuadrado
Exterior 430x430x175 interior 403x403 mm	F25000BE

## FREGADERO 1 SENO CUADRADO ENCASTRE



Fregadero 1 seno bajo encimera	Cuadrado
Exterior 497x416x155 interior 450x370 mm	FBE1SC

## FREGADERO 1 SENO CUADRADO ENCASTRE



Fregadero 1 seno bajo encimera	Cuadrado
Exterior 325x370x135 interior 300x340 mm	FB1SC40

\* Todas las medidas son aproximadas, la empresa no se hace responsable del uso de estas medidas para encastrar.

## FREGADERO 1 SENO CUADRADO ENCASTRE

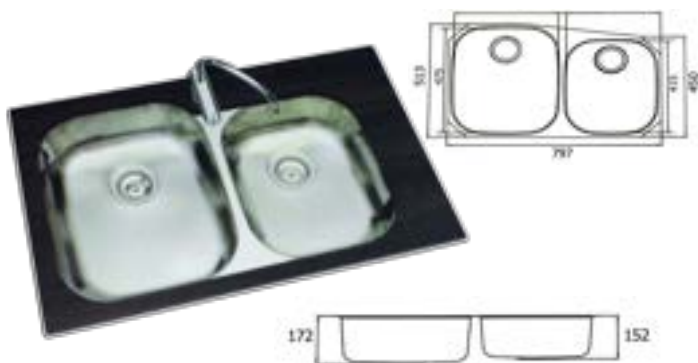

Fregadero 2 senos bajo encimera	Cuadrado
Exterior 797x450x172 Interior 797x475 mm	FBE2SC

## FREGADERO 2 SENOS CUADRADO ENCASTRE



Fregadero 2 senos bajo encimera	Cuadrado
Exterior 799x455x172 Interior 759x415 mm	F14178IN

\* Todas las medidas son aproximadas, la empresa no se hace responsable del uso de estas medidas para encastrar.

## FREGADERO 1 SENO CUADRADO



\* Todas las medidas son aproximadas, la empresa no se hace responsable del uso de estas medidas para encastre.

Medidas (mm)	Cuadrado
Exterior 540x460x150 interior 482x345 mm	F9055IN

## FREGADERO 1 SENO REDONDO



Medidas (mm)	Taladro	Redondo
Exterior 480x480x160 mm diámetro 380 mm	Si	F5000INT
Exterior 480x480x160 mm diámetro 380 mm	No	F5000IN

## 1 SENO CUADRADO Y ESCURRE



\* Todas las medidas son aproximadas, la empresa no se hace responsable del uso de estas medidas para encastre.

Cuadrado 1 seno y escurre	Cuadrado
Exterior 830x482x150 interior 362x418 mm	
Escurre a la derecha	F11000DEIN
Escurre a la izquierda	F11000IZIN
Sin taladro	F11000IN

## 1 SENO REDONDO Y ESCURRE

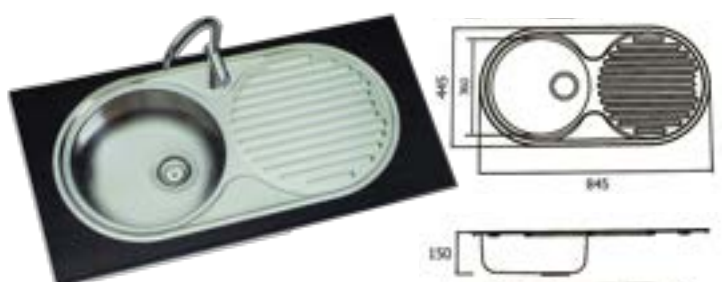

Redondo 1 seno y escurre	Redondo
Exterior 845x445x150 diámetro 360 mm	
Sin taladro	F7000IN
Escurre derecho	F7000DEIN
Escurre izquierdo	F7000IZIN

## 2 SENOS CUADRADOS



\* Todas las medidas son aproximadas, la empresa no se hace responsable del uso de estas medidas para encastre.

Cuadrado 2 senos cubeta 362x418 mm	Cuadrado
Exterior 830x482x150 con taladro	F10000INT
Exterior 830x482x150 sin taladro	F10000IN

## 2 SENOS REDONDOS



Redondo 2 senos	Redondo
Exterior 842x442x150 diámetro 360 mm	
Sin taladro	F6000IN
Con taladro	F6000INT

## 2 SENOS CUADRADOS Y ESCURRE



\* Todas las medidas son aproximadas, la empresa no se hace responsable del uso de estas medidas para encastre.

Fregadero 2 senos cuadrados y escurre	Cuadrado
Exterior 1005x505x150 mm	F18002IN

## 1 SENO CUADRADO + 1 SENO MINI



Redondo 2 senos	Redondo
635 x 475 2 senos (uno reducido)	F17000IN

# FREGADEROS LUXE

## FREGADERO LUXE 1 SENO

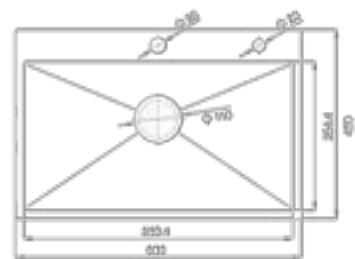

- Acabado acero inoxidable.
- Cubeta de gran capacidad.
- Resistente a golpes.
- Tratamiento de pulido de larga duración.
- Diseño antisalpicaduras.

\* Todas las medidas son aproximadas, la empresa no se hace responsable del uso de estas medidas para encastre

1 Seno	Fregadero + cubeta+ tabla
600x450x210 mm	FL3001IN

## FREGADERO LUXE 2 SENOS

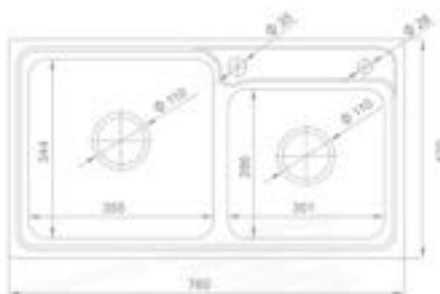

- Acabado acero inoxidable.
- Cubeta de gran capacidad.
- Resistente a golpes.
- Tratamiento de pulido de larga duración.
- Diseño antisalpicaduras.

\* Todas las medidas son aproximadas, la empresa no se hace responsable del uso de estas medidas para encastre



2 Senos	Fregadero + cestillo + tabla
760x420x210 mm	FL3002IN

## FREGADERO LUXE 1 SENO

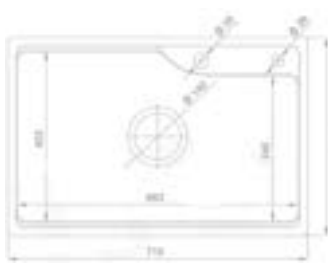

- Acabado acero inoxidable.
- Cubeta de gran capacidad.
- Resistente a golpes.
- Tratamiento de pulido de larga duración.
- Diseño antisalpicaduras.

\* Todas las medidas son aproximadas, la empresa no se hace responsable del uso de estas medidas para encastre

1 Seno	Fregadero + cestillo
710x470x210 mm	FL3003IN

## FREGADEROS DE RESINA



Fregadero 1 seno bajo/sobre encimera	NEGRO	BLANCO	Fregadero 1 seno y escurre	NEGRO	BLANCO
Exterior 440x440x200	F25000S40NG	F25000S40BL	Exterior 860x500x210	F11000NG	F11000BL

## GRIFERÍA



Grifo Gourmet Doble	Ref.
Cromo	GR1600CR



Grifo Gourmet	Ref.
Cromo	GR1500CR



Grifo Gourmet	Ref.
Inox	GR1400IN



Altura 440 mm Ø arco 225 mm

\* Manquera extraíble

Grifo extraíble caño redondo	Ref.
Inox	GR3100IN
Cromo	GR3100CR



Grifo curvo caño redondo	Ref.
Inox	GR1800IN
Cromo	GR1800CR



Grifo Caño Bajo	Inox
	GRPESCARACR



Grifo recto caño redondo	Ref.
Inox	GR3000IN
Cromo	GR3000CR
Negro	GR3000NG



Grifo recto caño redondo	Ref.
Inox	GR1900IN
Cromo	GR1900CR



Grifo Osmosis	Inox
Grifo de osmosis	GR2900IN



Grifo	Cromo
Grifo caño curvo	GR3200CR



Grifo	Cromo
Grifo Abatible	GRABATIBLE



Grifo caño curvo	Inox
	GR2800IN
	Cromo
	GR2800CR

Fregaderos  
Grifería

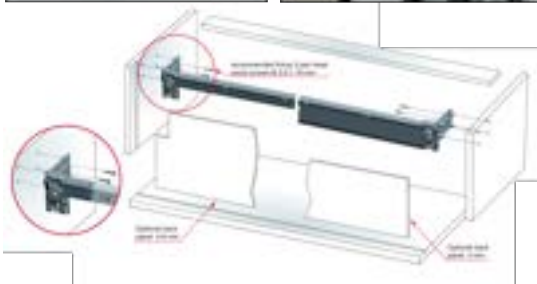
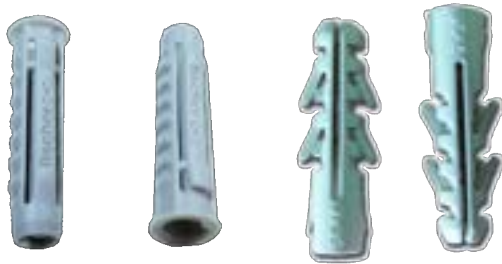
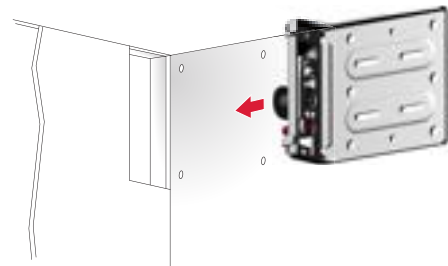
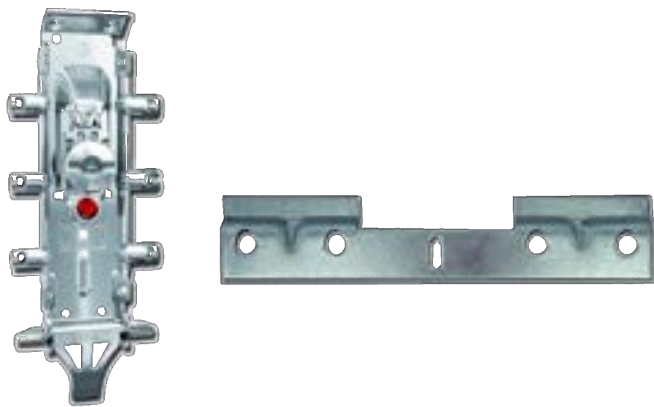



	PÁGINA
Colgadores y tornillería .....	96-97
Consumibles y siliconas .....	98-99

# HERRAJES CONSUMIBLES

# COLGADORES OCULTOS

## COLGADOR REVERSIBLE



- Capacidad de carga. 75 Kg garantizado alcanzando los 90 Kg con fijación el techo del modulo
- Regulación independiente vertical 13 mm y horizontal 12mm
- Eliminación "efecto leva" gracias a la fijación al techo.
- Acabado zincado para mayor protección al paso del tiempo.
- Sistema patentado antivuelco que evita la caída accidental del módulo.

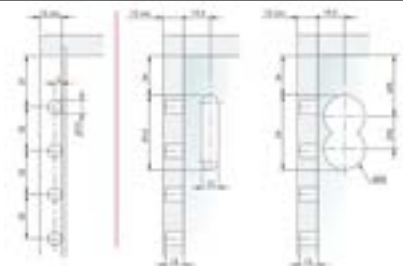

Colgador reversible	90912
Chapa doble	90903DE
Barra chapa 2 metros	90903B2

## COLGADORE NO REVERSIBLE CON TORNILLO SUPERIOR PREMONTADO



- Capacidad de carga. 70 Kg.
- Sistema antivuelco que evita la caída accidental del módulo.
- Tornillo premontado para fijación techo.

Colgador no reversible	
Colgador Izquierda	90913IZ
Colgador Derecho	90913DE
Chapa doble	90914

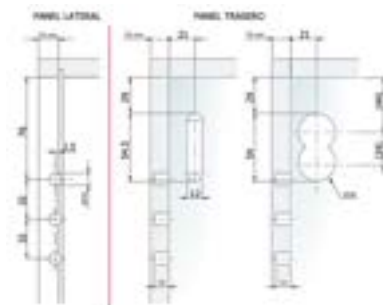

## COLGADOR ANTIVUELCO MUEBLES SUSPENDIDOS

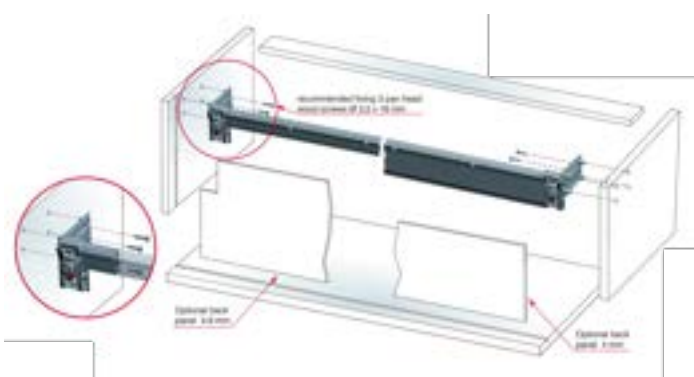

Colgador oculto con sistema antivuelco para muebles que vayan suspendidos. Debido a su gran capacidad de carga y máxima seguridad, consulte el sistema más idóneo según las características de sus muebles.

### Colgador muebles suspendidos

Jgo colgador (izq y der)	90911
Barra soporte 1200 mm	90911BC
Placa para colgador	90911P
Tornillo 45x4,2 colgador	90911T
Tuerca y tornillo colgador	90911TT

## COLGADOR CHAPA MUEBLES SUSPENDIDOS

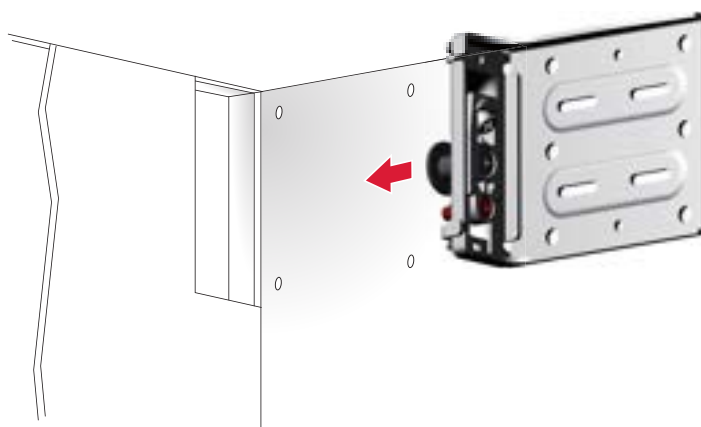

### Colgador muebles suspendidos

Jgo colgador (izq y der)	90915
Jgo tapas colgador (izq y der)	90916

## BARRA COLGADOR

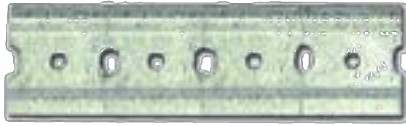

## CHAPAS



## CHAPA DOBLE



### Barra colgador 2 metros

Barra colgador 90903B2

### Chapas

Chapa pared 90903

### Chapa pared doble

Chapa pared 90903DE

## COLGADOR ESCUADRA

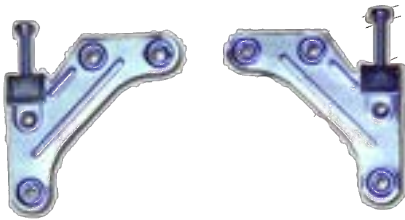

## GARROTA



## COLGADOR INTERIOR



### Colgadores escuadra

Colgador izquierdo 90901  
Colgador derecho 90902

### Garrotas

Garrota para colgar 90904

### Colgador interior

Blanco 90905  
Marrón 90905R

## TACOS (CAJAS)

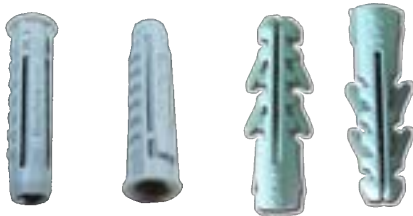

## PUNTAS



## TORNILLO ALLEN

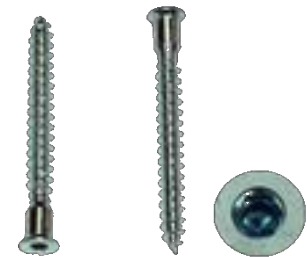

### Tipo Fisher

### Nylon

Medidas	Fisher	Standar
6 mm	909106F	909106
7 mm	909107100	909107
8 mm	909108F	909108

### Medidas

1x25 mm  
2x25 mm  
2x50 mm  
3x50 mm

### TIN

PTIN125  
PTIN225  
PTIN250  
PTIN350

### Medidas

5X50 mm  
5X50 mm ( Cajas)

### TIN

80650L  
80650L500

## TORNILLOS TIRADORES

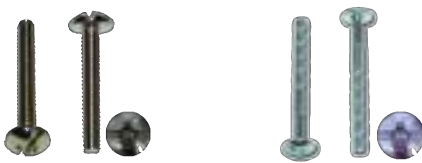

## TORNILLO TORX



\* Cajas completas

### Metrica 4 mm

### Multilargo

Medida	Zincado	Medida	Zincado
4x20	80420	4x40	80440
4x22	80422	4x45	80445
4x25	80425	4x50	80450
4x30	80430	4x45*	804ML

\* Multilargo, se puede cortar

### Ø

15 mm  
17 mm  
20 mm  
30 mm  
35 mm  
40 mm  
50 mm

### 3.5 mm

80TCT3515  
80TCT3517  
80TCT3520  
80TCT3530  
80TCT3535  
80TCT3540  
80TCT3550

### 4.0 mm

80TCT435  
80TCT440

## TORNILLO POZIDRIVE



\* Cajas completas

Ø	3.5 mm	4 mm	4.5mm	5 mm
16	80TP3516	80TP416		
20	80TP3520	80TP420		
25	80TP3525	80TP425		
30	80TP3530	80TP430		80TP530
40	80TP3540	80TP440	80TP4540	80TP540
45		80TP445	80TP4545	
50	80TP3550	80TP450	80TP4550	

# HERRAJES

## TOPE NIVELADOR



\* Con regulación de altura

Pata reguladora altura 30 mm

Negro	50560
Blanco	50560BL

## TOPE SILENCIOSO EMBUTIDO

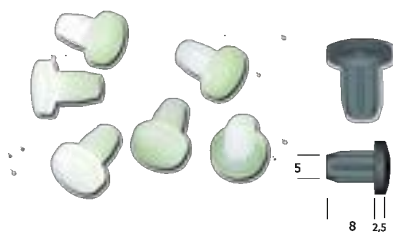

Pata reguladora altura 30 mm Ø 5 mm

Unitario	90239TR
Bolsa 1000 u.d	90239TR1000
Bolsa 5000 u.d	90239TR5000

## TOPE SILENCIOSO ADHESIVO



Topo adhesivo transparente

H- 3 mm	50552A
H- 1.5 mm	5052A15

## TOPE SILENCIOSO



Acabado	Unitario	1000 u..d
Blanco	5055210	5055210M
Roble	50552R	50552RM
Gris	50552G	50552GM

## TOPE TRASERO



Acabado	Unitario	1000 u..d
Blanco	5055110	5055110M
Roble	50551R	50551RM

## PASACABLES



Acabado	PVC
Blanco	PCPVC6010
Gris	PCPVC6018
Negro	PCPVC6019
Marrón	PCPVC6022

## TAPONES EMBELLECEDORES Ø 13 mm



Acabado	100 u.d.	Acabado	100 u.d.	Acabado	100 u.d.
Blanco	80TBLLC	Wengue	80TWC	Peral	80TPEC
Antracita	80TAC	Roble 4648	80T4648C	Cachemira Beige	80TTCHC
Negro	80TNGC	Haya	80THC	Cachemira Gris	80TTCHGC
Gris metalizado	80TGMC	Nogal	80TNC	Cachemira Marfil	80TTCHMAC
Gris rayado	80TGRC	Pino	80TPC	Beige	80TBC
Cerezo	80TCEC	Sapelly	80TSC	Roble	80TRC

## TAPÓN PARA BISAGRA



Medidas	Ø 35 mm
Blanco	T35BL
Marrón claro	T35CEW25
Marrón oscuro	T35MA
Gris	T35GC
Antracita	T35G

## RUEDA CON PLETINA



Rueda Altura 50 mm Ø 30 mm  
Rueda 16 kg 90R

## ESCUADRAS (Cajas)



Medidas	Escuadras
20x20 mm	80120100
30x30 mm	80130100
40x40 mm	80140

## TAPÓN ADHESIVO Ø 38 mm



Tapón adhesivo para cazoleta y taco Ø 38 mm  
Blanco T38BL  
\* Consultar otros acabados

## LIMPIADOR ENCIMERAS SUPER MATE



- Uso en Corian y Acrílico.
- Uso diario, quita grasa y suciedad.
- Capa Antibacteriana.
- No es peligroso, biodegradable y libre de disolventes.
- Limpia las encimeras sin salir manchas.
- Acabado limpio brillante.

Limpiador Encimeras super mate 500 ml  
LESM

## LIMPIADOR ACERO



Limpiador Acero inoxidable  
LAC

## PEGAMENTO CIANOCRILATO



Pegamento 50gr  
Spray 200ml

Pegamento 2  
componentes

Pegamento 2 componentes Cianocrilato

Conjunto peg + acil	PC1
Limpiador cianocrilato	LC

## ADHESIVO MONTAJE



Pegados de planchas galvanizadas, metales féreos o no féreos, elementos de caravanas o camiones. Pegado de paneles , tejas, placas, azulejos, espejos, apliques, molduras, fijación de objetos. Sellado de cristales, canalizaciones, cubiertas, tejas, marcos PVC/obra.

Adhesivo elástico de polímero monocomponente  
Bote 125 ml Blanca 90SFPT

## SILICONAS



Silicona	Normal	Neutra
Transparente	90STR	90SN
Blanca	90SBL	

## SELLADORES



Sellador	Polímero	Acrílico
Blanca	90SMS35	90SABL
Gris	90SMS35G	

## JGO. 5 HOJAS CALAR



Blister 5 hojas de calar MAKITA

Madera corte curvo	HSCMB17
Madera corte invertido	HSCMB19
Madera corte terminación	HSCMB12
Madera corte normal	HSCMB10

## COLA DE CONTACTO



Cola de contacto 175 ml  
90CC175

## COLA BLANCA



Cola blanca rápida 250 gr  
90CR250

## ESPUMA POLIURETANO



ESPUMA DE POLIURETANO (750 ml)

Bote 750 ml con canula	90SEP
Expansión controlada (Pistola)	90SEPECP
Bote 750 ml para pistola	90SEPP
Limpiador poliuretano	90SLP

## PISTOLA ESPUMA POLIURETANO



Pistola espuma poliuretano Calibre 30  
90SPT

## PISTOLA SILICONA



Pistola Silicona Dificil Extrusión  
90SPDE

## HOJA SEGUETA BI-METAL



Hoja segueta Bi-metal  
300x130x65 HS1224UL50

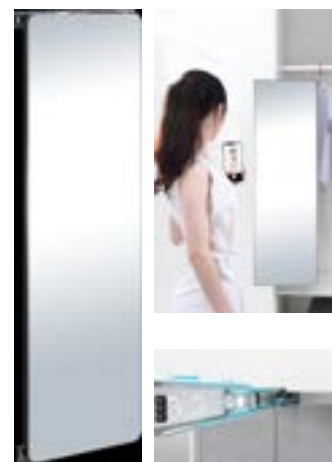
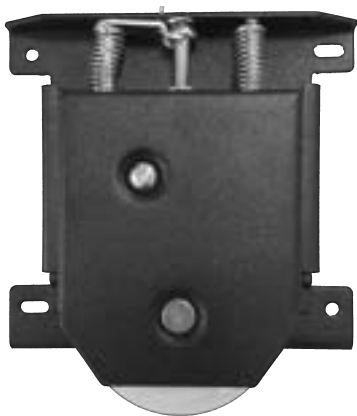

	PÁGINA
Armarios Hettich .....	102-103
Accesorios de armario .....	104-105
Perfilería y herrajes de armario .....	106-107
Herrajes de armario .....	108-109

# ARMARIOS

## SISTEMA DE PUERTAS PLEGABLES WING LINE L



Diseño elegante con efecto panorámico

- Gracias al sistema Push to move, con una ligera presión se puede abrir una superficie de armario de hasta 6m<sup>2</sup>
- Gracias al mecanismo de apertura asistida Pull to move, tirando levemente de la puerta, el sistema se abre y también se consigue acceder a todo el interior.

Una nueva dimensión de confort para las puertas plegables.

- Sistema de rodadura optimizado: Las puertas plegables se desplazan suave y silenciosamente hasta la posición final de apertura.

La técnica en resumen

- Sistema de puerta plegable de 2 puertas.
- Push to move mecánico o Pull to move apertura asistida.
- Puerta solapada en madera.
- Sensys es la bisagra recomendada.
- Peso máximo por hoja de puerta 25 Kg.
- Ancho máximo por hoja de puerta 600 mm.
- Altura máxima de puerta 2.400 mm.
- El perfil inferior se puede instalar por encima o por debajo de la base.
- También se puede usar sin perfil inferior.
- Ajuste en altura +/- 3 mm.
- Probado para 40.000 ciclos.
- Test según DIN EN 15706, Nivel III.

### Set de rodamientos

Tipo	25Kg		12Kg	
	Izquierdo	Derecho	Izquierdo	Derecho
Con cierre	9237852	9237890	9237882	9237906
Sin cierre	9237880	9237881	9237905	9237904

Set de Herrajes	Push to move		Pull to move		Pull Silent System	
	Izquierdo	Derecho	Izquierdo	Derecho	Izquierdo	Derecho
Ligera	9238102	9238113	9238117	9238118	9238120	9238119
Media	9238051	9238101	9238115	9238116	9238121	9238124
Pesada	9238052	9238053	9238125	9238114	9238123	9238122

### Set de perfiles Guía superior e inferior

1200 mm	9239311	2400 mm	9239 310
---------	---------	---------	----------

## SISTEMAS PUERTAS CORREDERAS SLIDELINE M (30Kg)



Arremetido Tirafondos



Arremetido Directo



Solapado 16 y 19 mm

Ancho min puerta	450 mm	300 mm	Peso
	Con freno	Sin freno	
Madera/Alum 55 mm	9201921	91456339	10 Kg
Madera/Alum 55 mm	9156338	91456339	30 Kg
Puerta cristal	9184595	9184596	--
Jgo. Complementario para marcos aluminio 19 mm			
Plata	9184626	9184629	
Negro	9184703	9184706	
Perfiles para rodamientos			
Grosor tablero	16 mm	19 mm	Medida
Solapado	9209165	9209167	2500
Tipo de Perfil	Montaje tirafondos	Montaje directo	Medida
Arremetido	9227245	9227246	2500

\* El ancho mínimo de la puerta que admite freno es de 450 mm consultar medidas y acabados



## SISTEMA DE PUERTAS CORREDERAS TOPLINE XL



Vídeo del producto

Vídeo del montaje



### Montaje fácil del amortiguador:

Calcular la posición del Silent System con fórmulas complicadas y mediciones precisas es cosa del pasado. Los amortiguadores se colocan fácilmente en la tapa y se atornillan.



### Ajuste de altura fácil:

Las puertas correderas se ajustan con mayor rapidez cuando están cerradas. La altura de la puerta se puede ajustar fácilmente desde la parte delantera y la alineación de fugas se puede comprobar directamente. En las construcciones a la altura del techo, el ajuste se realiza desde el lateral.

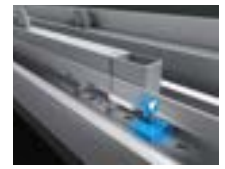

### Posición correcta garantizada:

Solo puede ser montado en una posición. No requiere activar el Silent System. De este modo se evitan averías y daños en el sistema



### Elegante acabado gracias al montaje por clip:

Realización de armarios de suelo a techo SIN tornillos a la vista.

### Estética impecable:

El perfil guía inferior está arremetido bajo el fondo, por lo que apenas es visible

### Perfil de rodadura personalizable:

Mediante tapas decorativas autoadhesivas disponibles en 3 acabados: champán, blanco y negro. La parte visible del perfil se puede combinar con el interior del armario.

### Protección innovadora para el montaje

Las puertas pueden descansar en el suelo sin preocupaciones de rotura antes de engancharlas.

Amortiguadores Silent System				
Peso max Kg	2 puertas	3 puertas	4 puertas	Grosor max mm
60	9275796	9275786	9278780	18-30
80	9275794	9275785	9278791	22-30
80	9275793	9275784	9278792	30-40
100	9275740	9275782		40-50

Amortiguadores Silent System			
Peso max Kg	2 puertas	3 puertas	4 puertas
15-35	9276735	9276648	9278798
30-80	9276732	9276647	9278799
60-100	9276737	9276649	

Perfil de rodadura y fijaciones		
medidas	Set de Perfiles	Set de fijaciones
2300 mm	9278672	9277708
4000 mm	9278657	9278080

## PUERTAS CORREDERAS FLOTANTES SYSLINE S (15 Kg)



### SysLine S: elegante y funcional

El nuevo SysLine S flota sobre los objetos. Las puertas se desplazan fácilmente como si flotaran. La amortiguación opcional Silent System garantiza un confort de movimiento perfecto. Y la técnica de gran calidad permanece invisible. Los perfiles de rodadura en el techo de armario confieren un look de alta calidad y un fácil acceso. La amortiguación Silent System opcional está integrada completamente. Resultado: óptimo diseño, máxima funcionalidad y confort convincente.



Armarios

Perfiles		
Bloqueo de giro	Montaje Tirafondos	Adhesivo
9136106	9136105	9145851

Set rodamiento	
Con amortiguación	Sin amortiguación
9134311	9136103

## COLECCIÓN LUXE (Extensibles de extracción total con freno, fondo 480mm)



### Organizador extensible

- Acabado antracita
- Caja con fieltro.

#### Medidas (mm)

560 -650mm  
660-750mm  
760-850mm  
860-950mm

#### Ref.

90LOE60A  
90LOE70A  
90LOE80A  
90LOE90A

### Zapatero extensible

- Acabado antracita
- Varillas modulares

#### Medidas (mm)

560 -650mm  
660-750mm  
760-850mm  
860-950mm

#### Ref.

90LZE60A  
90LZE70A  
90LZE80A  
90LZE90A



### Cesto extensible (Ratán)

- Acabado antracita.
- Cesto de ratán.

#### Medidas (mm)

560 -650mm  
660-750mm  
760-850mm

#### Ref.

90LCME60A  
90LCME70A  
90LCME80A



### Pantalonero con varillas

- Acabado antracita
- Varillas modulares

#### Medidas (mm)

560 -650mm  
660-750mm  
760-850mm  
860-950mm

#### Ref.

90LPTL60A  
90LPTL70A  
90LPTL80A  
90LPTL90A



## ESPEJO INTERIOR ARMARIO



Medidas:  
 - Ancho 350 mm  
 - Alto 1000 mm  
 - Grosor 50 mm



Espejo para atornillar al lateral del armario

Guías de extracción total con posibilidad de orientación del espejo.

Medidas(mm)	Ref.
390x85x1200	60EESA

## ZAPATERO EXTRAIBLE ROTABLE CON FRENO

Zapatero extraible rotatable con 4 bandejas de extracción total, freno y rotatable color Antracita



Medidas(mm)	Ref.
360x700xH(895-985)	ZER70CR

## PERCHA ABATIBLE ARMARIO



Peso maximo recomendado 10Kg  
 \* Consultar otros acabados

Medidas(mm)	Cromo	Antracita
450-600 mm	90PA4560	90PA4560A
600-830 mm	90PA6083	90PA6083A
830-115 mm	90PA83115	90PA83115A

## TABLAS DE PLANCHAR



Tabla de planchar articulada para atornillar a balda

Medidas  
800x300x110mm

Ref.  
TPAEN



Tabla para encastrar Frente abatible para extracción

Medidas  
970x380x190mm

Ref.  
TPAE



Tabla extraible para atornillar en lateral abatible con patas

Medidas (mm)  
1300x340x940mm

Ref.  
TPACP

## PERCHERO GIRABLE FIJACIÓN SUPERIOR



Medidas(mm)  
Ø 177 x 199 mm 360°

Cromo/ Blanco  
COBGP

## PERCHERO GIRABLE FIJACIÓN SUPERIOR

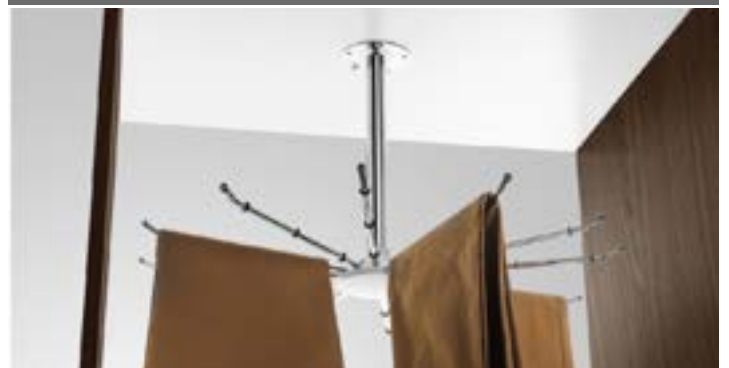

Medidas(mm)  
Ø 595 x 316 mm 360°

Cromo/ Blanco  
COBGG

## PARA COLGAR



Pantalonerero doble

Pantalonerero doble de extracción total con 20 perchas

Medidas(mm)	Cromo
460X640X160	PTLD



Pantalonerero 11 perchas

Extraíble de 11 perchas y extracción con o sin antideslizante

Modelos	Cromo.
Antideslizante	PTLG11PVC
Sin antides.	PTLGPE
Medidas 350x450x110 mm	

Pantalonerero rotable

Fijo al lateral con 6 perchas rotables



Perchero cromo brillo  
430x80 mm

PTLR

Pantalonerero lateral

Extracción parcial Lateral con 9 barras



Perchero cromo brillo-mate  
465x330x115

PTLEP9F

Perchero extracción parcial



Cromo brillo – Aluminio  
440x8x140 mm

PERCHE

Perchero/toallero extraíble

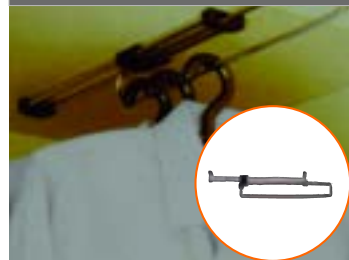

Cromo brillo – negro

450 mm T45NGCR  
400 mm T40ENGCR

Corbatero extraíble



Negro- Aluminio  
450 mm

COB

Toallero extraíble lateral



Cromo brillo

281 mm T281CR

## ZAPATEROS



Zapateros de extracción total extensibles

\* Fijación al frente opcional y acabado en cromo brillo

Medidas(mm)	Sin freno	Con freno
400 a 600 mm	ZEET4060F	ZEE4060FF
600 a 1000 mm	ZEET60100F	ZEE60100FF

Zapatero columna extraíble 4 pisos

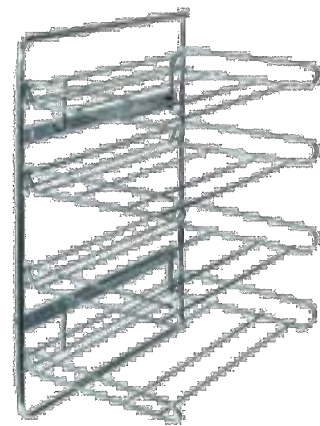

Zapatero 4 pisos

H 650 mm W 350 mm

Cromo brillo

ZE4P

Compás zapatero



Jgo. compás zapatero 2 baldas

272x225 mm

Blanco

90CZ2

Zapatero fijo extensible



Zapatero fijo extensible

48/83 mm  
83/113 mm

Cromo

Z4883  
Z83113

# PERFILERÍA DE ARMARIO

## TUBO ARMARIO RECTANGULAR



\* Consultar pedidos mínimos

Tubo cuadrado 30x12	Barra	Soporte central/lateral	Tapas	Soporte ciego
Gris 4 metros	60605G	60606G	6060TG	60607G
Antracita 4 metros	60605A	60606A	6060TA	60607A
Negro mate 4 m	60605NGM	60606NGM	6060TNGM	60607NGM
Blanco 4 metros	60605BL	60606BL	6060TBL	60607BL
Moka 4 metros	60605MK	60606MK	6060TMK	60607MK

## GUIA INFERIOR RECTA

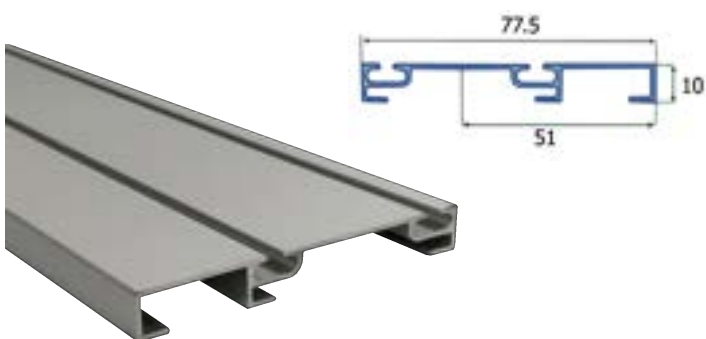

\* Barras de 3 y 6 metros, consultar otras medidas y acabados



\* Soporte guía inferior recta

Acabado	3 metros	4 metros	6 metros
Plata mate	60450CM3	60450CM4	60450CM
Blanco	60450BLN		60450BLN6
Haya	60450HY		
Roble	60450RB		
Soportes	60451		

## TUBO ARMARIO OVAL



Tubo Oval 30x15	Plata	Oro	Titanio
Barra 4 metros	60600CR	60600OV	60600T
Soporte lateral	60602CR	60602OR	60602T
Soporte central	60601CR	60601OR	60601T
Soporte ciego	60604CM		

## GUÍA SUPERIOR

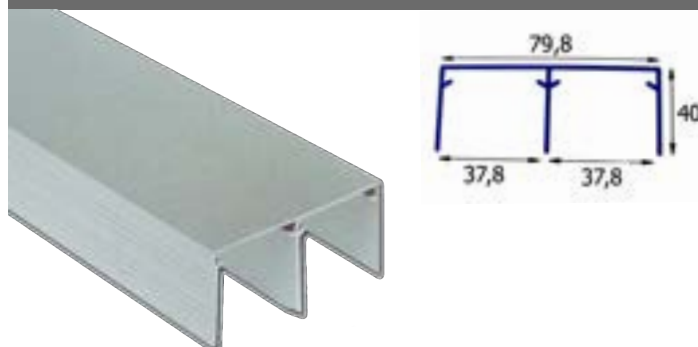

\* Barras de 3 y 6 metros, consultar otras medidas y acabados

Acabado	3 metros	4 metros	6 metros
Plata mate	60470CM3	60470CM4	60470CM
Blanco	60470BLN		60470BLN6
Oro	60470OR3		
Roble	60470R		
Pino	60470HY		
Haya	60470S		
Sapelly	60470		
Plata brillo	60470CR		

## GUIA INFERIOR Y TAPA



\* Barras de 3 y 6 metros, consultar otras medidas y acabados

Acabado	3 metros	4 metros	6 metros	Tapa
Plata mate	60471CM3	60471CM4	60471CM	60472CM
Blanco	60471BL		60471BL6	60472BL
Plata brillo	60471CR			60472CR
Negro	60471NG			60472NG
Oro	60471OR			60472OR3
Haya				60472HY
Cerezo				60472C
Pino				60472P
Roble				60472R3
Sapelly				60472S

## PERFIL TIRADOR CLÁSICO

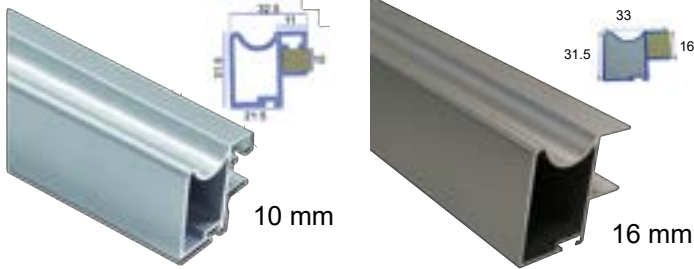

\* Barras de 2,60 metros, consultar otras medidas y acabados

Acabado	16 mm	10 mm
Plata mate	60455CM	6045510CM
Blanco	60455BLN	6045510BL
Oro	60455OR	6045510OR
Cromo brillo	60455CR	
Roble	60455RB	
Haya	60455HY	
Pino	60455P	

## PERFIL TIRADOR RECTO

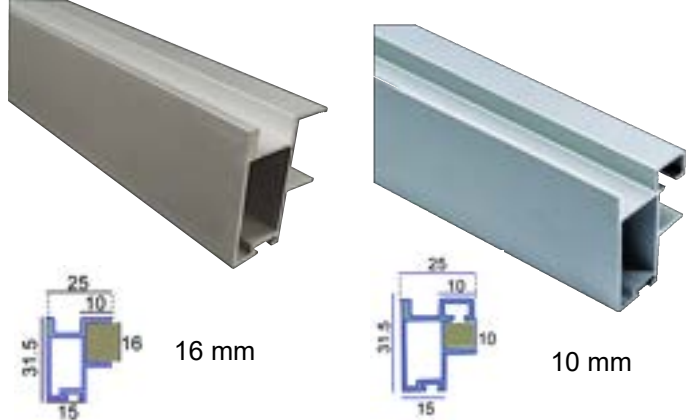

\* Barras de 2,60 metros, consultar otras medidas y acabados

Acabado	19 mm	16 mm	10 mm
Plata mate	6045619CM	6045616CM	6045610CM
Blanco	6045619BL	6045616BL	6045610BL

## PERFIL TIRADOR CURVO

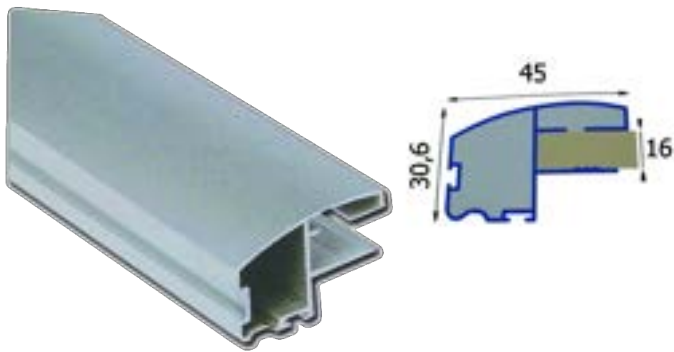

\* Barras de 2,60 metros, consultar otras medidas y acabados

Acabado	16 mm	10 mm
Plata mate	6048516CM	6048510CM
Blanco	6048516BL	6048510BL

## TIRADOR REDUCIDO 10 mm

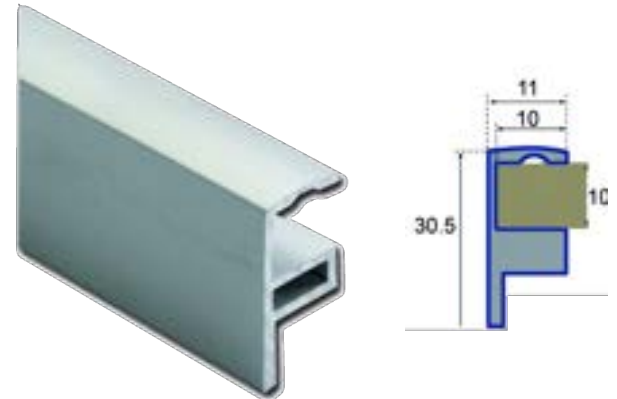

\* Barras de 2,60 metros, consultar otras medidas y acabados

Acabado	Plata mate	Blanco
10 mm	60454CM	60454BL

## TIRADOR MINIMALISTA 10 mm



\* Barras de 2,60 metros, consultar otras medidas y acabados

Acabado	Plata mate	Blanco
10 mm	60486CM	60486BL

## PERFILES "H" Y "U"

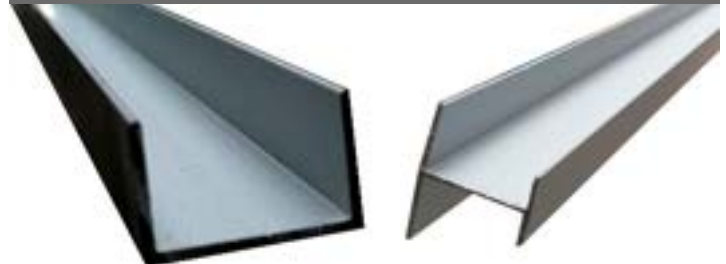

Perfil "U" Cantonera

Perfil "H" Reducido

\* Barras de 3 y 6 metros, consultar otras medidas y acabados

	3 metros	19 mm	16 mm	10 mm
Perfil "U" Plata mate		6045319CM	60453CM	6045310CM
Perfil "U" Blanco		6045319BL	60453BL	
Perfil "H" Plata mate		6048719CM	60487CM	6047610CM
Perfil "H" Blanco		6048719BL	60476BLN3	

# HERRAJES PARA ARMARIO

## RUEDA INFERIOR

\* Silenciosa



Tornillo de bloqueo

Rueda inferior

Con regulación	60495
Con regulación y bloqueo	60473TB

## RUEDA SUPERIOR



Rueda Superior

Tablero de 16 mm	60474
Tablero de 19 mm	6047419

## FILM ADHESIVO PROTECTOR CRISTAL



Film adhesivo protector

Negro	60FACRN
-------	---------

## BLOQUEO RUEDA



Bloqueo Rueda

Zamaq	60475
-------	-------

## CEPILLO



Cepillo 6.5x8 mm

Gris	60459
------	-------

## JUNQUILLO REDUCTOR



Junquillo de goma reductor

16 mm	60479
10 mm	60489

## PLACA UNIÓN

Hettich



Placa de unión

Acero cincado	90906
---------------	-------

## FRENO ARMARIO



Freno armario con regulación

Freno armario con rueda superior	60483RF
----------------------------------	---------

## CURVA PARA TUBO OVAL

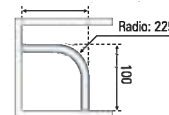
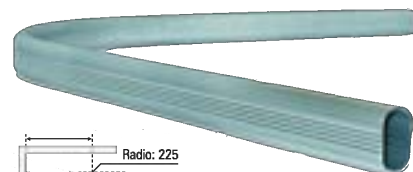

Curva para tubo oval 1x1 metro

Plata	60603CM100
Oro	60603OR

## PERFIL UNIÓN PUERTAS

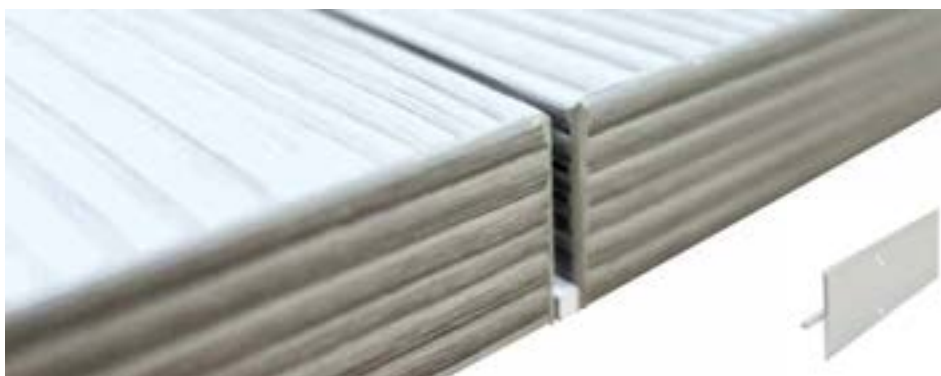

Ancho	Aluminio Alto 40 mm
277 mm	PUP277
427 mm	PUP427
577 mm	PUP577



## UNIÓN DOBLE CON EXCÉNTRICA



Unión excéntrica doble para armario

Casco 19 mm	8011819
Casco 16 mm	80118

## UNIÓN DOBLE CON EXCÉNTRICA



VB 36  
19/VB

DU 321

DU 712

DU 322

Unión excéntrica doble para armario Hettich

VB 36 M / 19	65521
VB 36 M / 16	65517

Tornillos para excéntricas Hettich

Tornillo para roscar DU 321	74688
Tornillo para roscar DU 322	64872
Tornillo doble DU 712	65535

## TOPE / PATA REGULADORA



Tope / Pata regulador

Regulación 20mm	50561
-----------------	-------

## PATA REGULADORA



Pata regulador 20 mm

Altura 60 mm	50ATA60
--------------	---------

## UNIÓN SIMPLE CON EXCÉNTRICA

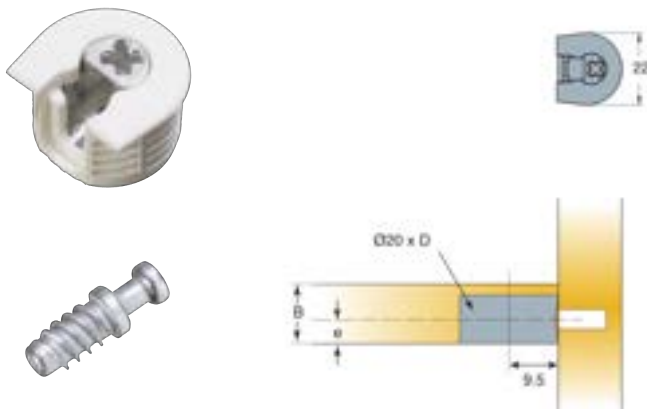

Unión excéntrica simple para armario

Casco 19 mm	8011919
Casco 16 mm	8011916

## UNIÓN SIMPLE CON EXCÉNTRICA



VB 35  
19/VB

DU 321

DU 712

DU 322

Unión excéntrica simple para armario Hettich

VB 35 M / 19	65505
VB 35 M / 16	65501

Tornillos para excéntricas Hettich

Tornillo para roscar DU 321	74688
Tornillo para roscar DU 322	64872
Tornillo doble DU 712	65535



Plantillas y Maquinaria.....

PÁGINA

114-115

# AYUDAS PLANIFICACIÓN

## MAQUINA DE MECANIZADO DE BISAGRAS E INSERCIÓN



**Modular** 90H9156858

**BlueMax Mini Modular con accesorios, 1,1 kW / 230 V / 50 Hz / 3 fases**

Máquina para taladrar e insertar en diseño compacto con técnica de taladrado intercambiable

- AccionBlueMax Mini Modular con accesorios, 1,1 kW / 230 V / 50 Hz / 3 fases
- Accionamiento neumático- Mesa de trabajo regulable
- Limitador mecánico de carrera de taladrado
- 2 topes de cilindro para ajuste de profundidad 22, 37, 57 mm de la regla de tope
- 1 cabezal de taladrado intercambiable, 6 husillos con portabrocas de cambio rápido
- 6 soportes de brocas para portabrocas de cambio rápido
- 1 depósito para herramientas
- 2 pisones (izquierdo / derecho)
- 1 tope central con escala- 2 topes basculantes



**Type 3** 90H77567

**BlueMax Mini tipo 3, 0,8 kW / 230 V / 50 Hz / 3 fases**

Máquina para taladrar e insertar en diseño compacto

- Accionamiento neumático
- Cabezal de taladrado con 6 husillos
- Regla de tope con mesa de trabajo
- 2 topes basculantes



**Set** 90H70033

Juego de brocas para BlueMax Mini tipo 3, BlueMax Mini tipo 2 / 6 (1x ø 35 mm derecha, 2 x ø 10 mm izquierda, 2 x ø 5 mm izquierda)



**Type 2/6** 90H47222

**BlueMax Mini Modular con accesorios, 1,1 kW / 230 V / 50 Hz / 3 fases**

Máquina para taladrar e insertar en diseño compacto con técnica de taladrado intercambiable

- AccionBlueMax Mini Modular con accesorios, 1,1 kW / 230 V / 50 Hz / 3 fases
- Accionamiento neumático- Mesa de trabajo regulable
- Limitador mecánico de carrera de taladrado
- 2 topes de cilindro para ajuste de profundidad 22, 37, 57 mm de la regla de tope
- 1 cabezal de taladrado intercambiable, 6 husillos con portabrocas de cambio rápido
- 6 soportes de brocas para portabrocas de cambio rápido
- 1 depósito para herramientas
- 2 pisones (izquierdo / derecho)
- 1 tope central con escala- 2 topes basculantes

## PLANTILLA ACCURA PARA BISAGRAS Y SISTEMAS DE CAJONES



Brazo Accura



	5 mm	10 mm
Broca Casquillo	90H70268	90H78096



Plantillas y topes  
Guías y Bisagras

Brazo 1500 mm	Brazo 2000 mm	Set topes	Plantilla Bisagras	Plantilla Guías
90H20014	90H70264	90H9139574	90H13841	90H70265

## BROCA CAZOLETA



Broca cazoleta Ø 35 mm

Widia	BR54Y3557
Hettich	90H9106101

## PLANTILLA CAZOLETAS



Facilita el posicionamiento de los taladros de cazoletas para las bisagras, también en caso de un montaje posterior de las puertas. Para insertar en los taladros de suplementos o hileras de taladros Sistema 32.

Plantilla	90H9078866
-----------	------------

## PLANTILLA BASES BISAGRAS



La plantilla para marcar de doble cara MultiBlue permite el marcado de - Taladros de sistema en trama 32 para, - Taladros de la cazoleta Ø 35 y Ø 26 con medida C 4 mm para bisagras - Taladros Ø 25 para conjunto de unión Rastex 25- Taladros Ø 20 para conjuntos de unión VB 35 y VB 135

Plantilla	90H00351
-----------	----------

## PLANTILLA TRASERA AVANTECH



Para taladrar traseras de madera/aluminio AvanTech YOU:

Ensambladura de costados  
Alturas de costado 101 / 139 / 187 / 251 mm  
Plástico  
Casquillos guía de acero templado para brocas de 4 mm.

Avantech	90H9257321
----------	------------

## PLANTILLA FRENTE AVANTECH YOU



Para taladrar los agujeros para la fijación de frente en AvanTech YOU:

Cajón / cacerolero  
Casquillos guía de acero templado para brocas de 10 mm con tope de ajuste de profundidad.

Plantilla	90H9219328
-----------	------------

## PLANTILLA PARA FRENTE



Tope angular para la combinación con plantilla para taladrar Practica para- AvanTech YOU / ArciTech

Plantilla	90H78093
-----------	----------

## PLANTILLA PARA BISAGRAS



Para el montaje preciso de bisagras en productos personalizados o especiales o para el equipamiento posterior de puertas en la empresa del cliente

Bisagras	90H20165
----------	----------

## PLANTILLA UNIVERSAL DTC

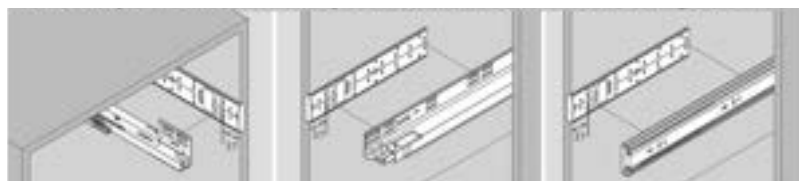

Cajón Tekno it

Guía Oculta Tekno

Guía Telescópica



Bases Bisagras

Mecanismo elevación DTC

Mecanismo elevación XL

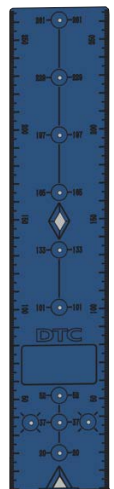

Plantilla	90TDT02
-----------	---------



	Página
Tiradores modernos .....	118-161
Pomos .....	162-166
Tiradores clásicos .....	167-181

# TIRADORES Y POMOS

# TIRADOR COLECCIÓN MODERNA

## TIRADOR 4537



Distancia taladros	Inox
224 mm	4537224IN

## TIRADOR 4540



Distancia taladros	Cromo mate
192 mm	4540192CM

## TIRADOR 4542



Distancia taladros	Cromo mate	Cromo mate
128 mm	4542128CM	
160 mm		4542160COB
192 mm	4542192CM	

## TIRADOR 4543



Distancia taladros	Cromo mate	Negro
192 mm	4543192CM	4543192NG



## TIRADOR 4544



Distancia taladros	Cromo mate
160 mm	4544160CM

## TIRADOR 4545



Distancia taladros	Cromo mate
256 mm	4545256CM

## TIRADOR 4546



Medidas	Cromo mate
160 mm	4546160CM

## TIRADOR 4539



Dist. taladro	Cromo mate	Cromo brillo
32 mm	453932CM	453932CR

Tiradores modernos

# TIRADOR COLECCIÓN MODERNA

## TIRADOR 5000



Distancia	Antracita	Gris	Blanco	Oro	Bronce
160 mm	5000160A	5000160GR	5000160BL	5000160O	5000160BC
320 mm	5000320A	5000320GR	5000320BL	5000320O	5000320BC
Pomo	5000A	5000GR	5000BL	5000O	5000BC

\* Artículo por encargo, consultar condiciones y cantidades

## TIRADOR 5001



Distancia	Antracita	Gris	Blanco	Oro	Bronce
160 mm	5001160A	5001160GR	5001160BL	5001160O	5001160BC
320 mm	5001320A	5001320GR	5001320BL	5001320O	5001320BC
Pomo	5001A	5001GR	5001BL	5001O	5001BC

\* Artículo por encargo, consultar condiciones y cantidades

## TIRADOR 5003



Distancia	Antracita	Gris	Blanco	Oro	Bronce
160 mm	5003160A	5003160GR	5003160BL	5003160O	5003160BC
320 mm	5003320A	5003320GR	5003320BL	5003320O	5003320BC

\* Artículo por encargo, consultar condiciones y cantidades

## TIRADOR 5004



Distancia	Antracita	Gris	Blanco	Oro	Bronce
160 mm	5004160A	5004160GR	5004160BL	5004160O	5004160BC
320 mm	5004320A	5004320GR	5004320BL	5004320O	5004320BC

\* Artículo por encargo, consultar condiciones y cantidades

# TIRADOR 5002



Distancia	Antracita	Gris	Blanco	Oro	Bronce
160 mm	5002160A	5002160GR	5002160BL	5002160O	5002160BC
320 mm	5002320A	5002320GR	5002320BL	5002320O	5002320BC
Pomo	5002A	5002GR	5002BL	5002O	5002BC

\* Artículo por encargo, consultar condiciones y cantidades

# TIRADOR 5005



Distancia	Antracita	Gris	Blanco	Oro	Bronce
160 mm	5005160A	5005160GR	5005160BL	5005160O	5005160BC
320 mm	5005320A	5005320GR	5005320BL	5005320O	5005320BC

\* Artículo por encargo, consultar condiciones y cantidades

# TIRADOR 5006



Distancia	Antracita	Gris	Blanco	Oro	Bronce
160 mm	5006160A	5006160GR	5006160BL	5006160O	5006160BC
320 mm	5006320A	5006320GR	5006320BL	5006320O	5006320BC

\* Artículo por encargo, consultar condiciones y cantidades

# TIRADOR 5007



Distancia	Antracita	Gris	Blanco	Oro	Bronce
160 mm	5007160A	5007160GR	5007160BL	5007160O	5007160BC
320 mm	5007320A	5007320GR	5007320BL	5007320O	5007320BC

\* Artículo por encargo, consultar condiciones y cantidades

Tiradores modernos

# TIRADOR COLECCIÓN MODERNA

## TIRADOR 5008



\* Artículo por encargo, consultar condiciones y cantidades

Distancia	Antracita	Gris	Blanco	Oro	Bronce
160 mm	5008160A	5008160GR	5008160BL	5008160O	5008160BC
320 mm	5008320A	5008320GR	5008320BL	5008320O	5008320BC

## TIRADOR 4525



Distancia taladro	Inox	Cromo brillo
160 mm	4525160IN	4525160CR

## TIRADOR 4527



Distancia taladro	Inox	Negro
160 mm	4527160ININ	4527160INNG

## TIRADOR 4528



Distancia taladro	Inox
160 mm	4528160IN
320 mm	4528320IN

## TIRADOR 4529



Distancia taladro	Cromo brillo
160 mm	4529160CR

## TIRADOR 4530



Distancia taladro	Inox
160 mm	4530160IN

Tiradores modernos

## TIRADOR 4531



Distancia taladro	Cromo brillo
160 mm	4531160CR

## TIRADOR 4535



Distancia taladro	Inox
160 mm	4535160IN

# TIRADORES MODERNOS

## TIRADOR 4188



Dist	Cromo mate	Dist	Cromo mate
160 mm	4188160MCM	497 mm	4188497MCM
347 mm	4188347MCM	797 mm	4188797MCM

## TIRADOR 4449



Dist.	Inox
384 mm	4449384IN
544 mm	4449544IN

## TIRADOR 4489



Dist.	Cromo mate
160 mm	4489160CM
256 mm	4489256CM
320 mm	4489320CM

## TIRADOR 4190



Dist.	Cromo mate	Dist.	Cromo mate
160 mm	4190160MCM	532 mm	4190532MCM
192 mm	4190192MCM	672 mm	4190672MCM
320 mm	4190320MCM	736 mm	4190736MCM

# TIRADOR 4429



Dist.	Inox	Dist.	Inox
128 mm	4429128IN	484 mm	4429484INOX
184 mm	4429184IN	684 mm	4429684IN
334 mm	4429334IN		

Tiradores modernos

# TIRADOR 4080 Inoxidable macizo



Consultar otras medidas

Dist	Inox 14mm Ø	Inox 12 mm Ø	Dist	Inox 14mm Ø	Inox 12 mm Ø
96 mm	408096IN	408096IN12	448 mm	4080448IN	4080448IN12
128 mm	4080128IN	4080128IN12	492 mm	4080492IN	
160 mm	4080160IN	4080160IN12	544 mm	4080544IN	4080544IN12
192 mm	4080192IN	4080192IN12	592 mm	4080592IN	
256 mm	4080256IN	4080256IN12	736 mm	4080736IN	4080736IN12
320 mm	4080320IN	4080320IN12	792 mm	4080792IN	
342 mm	4080342IN	4080342IN12	896 mm	4080896IN	4080896IN12
384 mm	4080384IN	4080384IN12	960 mm	4080960IN	4080960IN12
392 mm	4080392IN		1156 mm	40801156IN	
442 mm	4080442IN		1192 mm	40801192IN	40801192IN12

# TIRADORES MODERNOS

## TIRADOR 4462



Distancia taladro	Cromo brillo	Cromo mate
160-192 mm	4462160192CR	4462160192CM
288-320 mm	4462288320CR	4462288320CM
448-480 mm	4462448480CR	4462448480CM

## TIRADOR 4450



Dist.	Cromo brillo
160 mm	4450160CR
192 mm	4450192CR
320 mm	4450320CR

## TIRADOR 4534



Dist.	Inox
160 mm	4534160IN

## TIRADOR 4463



Dist.	Antracita	Cromo brillo	Cromo mate
96-128		446396128CR	446396128CM
160-192	4463160192A	4463160192CR	4463160192CM
288-320		4463288320CR	4463288320CM



## TIRADOR 4497



Dist.	Cromo Brillo
192 mm	4497192CRCR

## TIRADOR 4522



Dist.	Negro Cobalto
192 mm	4522192NGC

## TIRADOR 4533 (Hueco)



Dist.	Inox
160 mm	4533160IN

## TIRADOR 4496



Distancia taladro	Cromo brillo	Inox
160 mm	4496160CR	4496160IN
320 mm	4496320CR	4496320IN

Tiradores modernos

# TIRADORES MODERNOS

## TIRADOR 4434



Dist.	Cromo brillo	Inox
160 mm	* Consultar	4434160IN
320 mm	4434320CR	4434320IN

## TIRADOR 4439



Dist.	Inox
160 mm	4439160IN
256 mm	4439256IN

## TIRADOR 4519



Distancia taladros	Cromo mate	Inox
128 mm	4519128CM	4519128IN
160 mm	4519160CM	4519160IN
256 mm	4519256CM	

## TIRADOR 4508



Distancia taladros	Inox
192	4508192IN

## TIRADOR 4518



Distancia taladros	Inox
160	4518160IN

## TIRADOR 4506



Distancia taladros	Inox
160	4506160IN

## TIRADOR 4517



Distancia taladros	Inox
160	4517160IN

## TIRADOR 4511



Distancia taladros	Inox
160	4511160IN

Tiradores modernos

# TIRADORES MODERNOS

## TIRADOR 4507



Distancia taladros	Inox	Cromo brillo
192 mm	4507192IN	4507192CR
320 mm	4507320IN	4507320CR

## TIRADOR 4515



Distancia taladros	Inox	Cromo brillo
160 mm	4515160IN	4515160CR
224 mm	4515224IN	4515224CR

## TIRADOR 4445



Distancia taladros	Cromo brillo	Inox
192 mm	4445192CR	4445192IN
320 mm		4445320IN

## TIRADOR 4513



Distancia taladro	Cromo mate	Distancia taladro	Cromo mate
128 mm	4513128CM	192 mm	4513192CM
160 mm	4513160CM	256 mm	4513256CM

## TIRADOR 4510



Distancia taladros	Inox
160 mm	4510160IN

Tiradores modernos

## TIRADOR 4452



Distancia taladros	Cromo brillo
160 mm	4452160CR
320 mm	4452320CR

## TIRADOR 4471



Distancia taladros	Cromo mate
160-192 mm	4471160192CM

# TIRADORES MODERNOS

## TIRADOR 4512



Distancia taladros	Cromo mate
192 mm	4512192CM

## TIRADOR 4493



Distancia taladro	Cromo mate
160 mm	4493160CM
320 mm	4493320CM

## TIRADOR 4433



Distancia taladro	Inox
160 mm	4433160IN
320 mm	4433320IN

## TIRADOR 4172



Distancia taladros	Inox
192 mm	4172192IN

## TIRADOR 4420



Pomo distancia 32 mm

Tirador moderno formas curvas y pomo a juego, diferentes acabados incluyendo cristal strass

\* Consultar pedido mínimo

Dist mm	Cristal Strass	Cromo brillo	Cromo mate	Inox.
128 160	4420128160CRST		4420128160	4420128160IN
320 288	4420288320CRST	4420288320CR	4420288320CM	4420288320IN

## TIRADOR 4464



Tiradores modernos

Distancia taladro	Cromo mate	Inox
160-192 mm	4464160192CM	4464160192IN
224-256 mm	4464224256CM	4464224256IN

## TIRADOR 4466



Distancia taladro	Cromo mate	Inox
192 mm	4466192CM	4466192IN
320 mm	4466320CM	4466320IN

## TIRADOR 4480



Distancia taladro	Cromo brillo	Inox
128 mm	4480128CR	4480128IN

# TIRADORES MODERNOS

## TIRADOR 4437



Distancia taladro	Inox
160 mm	4437160IN

## TIRADOR 4410



Distancia taladro	Cromo mate	Inox
192 mm	4410192CM	
224 mm		4410224IN

## TIRADOR 4407



Distancia taladro	Cromo brillo	Inox
160 mm	4407160CR	4407160IN
320 mm	4407320CR	4407320IN

## TIRADOR 4509



Distancia taladro	Inox
160	4509160IN
224	4509224IN



## TIRADOR 4025



Distancia taladro	Cromo mate	Cromo brillo	Blanco
128 mm	20125X	20125CR	2012510

## TIRADOR 4504



Distancia taladro	Cromo brillo	Inox
160 mm	4504160CR	4504160IN

Tiradores modernos

## TIRADOR 4505



Distancia taladro	Cromo mate
192 mm	4505192CM

## TIRADOR 4503



Distancia taladros	Inox
192 mm	4503192IN

# TIRADORES MODERNOS

## TIRADOR 4500



Distancia taladros

192 mm

Inox

4500192IN

## TIRADOR 4419



Distancia taladro

128-160 mm

320-352 mm

Inox

4419128160IN

4419320352IN

Cromo mate

4419128160CM

4419320352CM

## TIRADOR 4465



Distancia taladro

128-160 mm

320 mm

Inox

4465128160IN

4465320IN

Cromo mate

4465128160CM

4465320CM

## TIRADOR 4418



Distancia taladros

160 mm

320 mm

Cromo mate

4418160CM

4418320CM

# TIRADOR 4135



Tiradores modernos

Dist. taladro	Cromo mate	Inox	Blanco	Negro	Cobre mate	Oro mate
128 mm	4135128MCM					
160 mm		4135160IN	4135160BL	4135160NG	4135160COM	4135160ORM
256 mm	4135256CM	4135256IN	4135256BL			

# TIRADOR 4469



Distancia taladros	Cromo brillo	Blanco	Negro	Oro mate
128 mm	4469128CR	4469128BL	4469128NG	4469128ORM
224 mm		4469224BL	4469224NG	4469224ORM
320 mm	4469320CR			

# TIRADORES MODERNOS

## TIRADOR 4553



Distancia taladro	Cromo brillo	Inox	Negro
160 mm	4553160CR	4553160IN	4553160NG
224 mm	4553224CR	4553224IN	4553224NG

## TIRADOR 4473 ALUMINIO



Dist.	Aluminio
156 mm	4473140AL
440 mm	4473440AL

## TIRADOR 4155



Distancia taladros	Cromo mate
128 mm	4155128MCM

## TIRADOR 4140



Distancia taladro	Cromo mate
128 mm	4140128MCM
160 mm	4140160MCM

Tiradores modernos

## TIRADOR 4037



Distancia taladro	Cromo mate
96 mm	20137LX

## TIRADOR 4440



Distancia taladros	Inox
128 mm	4440160IN

# TIRADORES MODERNOS

## TIRADOR 4481



Distancia taladro	Inox	Cromo brillo
160 mm	4481160IN	4481160CR

## TIRADOR 4459



Distancia taladros	Cromo mate
192 mm	4459192CM

## TIRADOR 4430



Distancia taladros	Cromo brillo
160 mm	4430160CRIN

## TIRADOR 4432



Distancia taladros	Inox
160 mm	4432160IN

## TIRADOR 4194



Distancia taladros	Inox
128 mm	4194128IN

Tiradores modernos

## TIRADOR 4409



Distancia taladros	Inox Cromo brillo
160 mm	4409160INCR

## TIRADOR 4408



Distancia taladros	Cromo brillo Cromo mate
160 mm	4408160CRMCM

# TIRADORES MODERNOS

## TIRADOR 4467



Distancia taladros

160 mm

Cromo mate

4467160CM

## TIRADOR 4136



Distancia taladros

128 mm

Cromo mate

4136128CM

## TIRADOR 4526



Distancia taladros

160 mm

Inox

4526160IN

## TIRADOR 4122

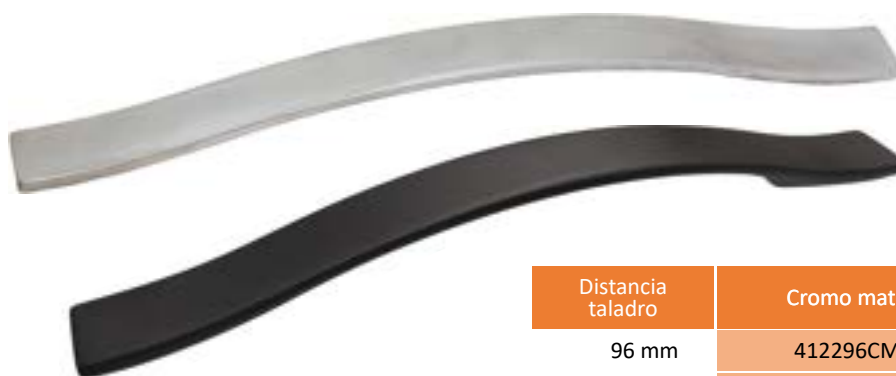

Distancia taladro

96 mm

160 mm

Cromo mate

412296CM

4122160CM

Negro

4122160NG



## TIRADOR 4184



Tirador moderno acabado inox con formas rectas.  
Varias medidas

Distancia taladros	Inox
32 mm	418432IN
64 mm	418464IN

## TIRADOR 4435 Y POMO 4864



443596IN



4864

Distancia taladros		Inox	
96 mm		443596IN	
Dist.	Cromo Brillo	Cromo mate	Inox
45x20 mm	4864CR	4864CM	4864IN

Tiradores modernos

## TIRADOR 4412



Tirador moderno acabado Cromo mate con formas rectas

Medida tirador	Cromo mate
55x55 mm	4412MCM

## TIRADOR 4185



Tirador moderno acabado Cromo mate para sistemas PUSH

Medida tirador	Cromo mate
30x30 mm	418530CM

## TIRADOR 4152



Distancia taladro	Inox
160 mm	4152160IN

## TIRADOR 4107



Distancia taladro	Cromo mate	Inox
128 mm	4107128CM	
160 mm	4107160CM	4017160IN
192 mm	4107192CM	

## TIRADOR 4161



Distancia taladro	Inox
160 mm	4161160IN

## TIRADOR 4165



Distancia taladros	Cromo mate	Inox
128-160 mm	4165128160CM	
192-224 mm		4165192224IN

## TIRADOR 4478



Distancia taladros	Cromo brillo
160 mm	4478160CR

## TIRADOR 4479



Distancia taladros	Cromo brillo
160 mm	4479160CR

## TIRADOR 4483



Distancia taladros	Inox
160 mm	4483160IN

## TIRADOR 4501



Distancia taladros	Inox
160 mm	4501160IN

Tiradores modernos

# TIRADORES MODERNOS

## TIRADOR 4402



Distancia taladro

128 mm

Inox

4402128IN

## TIRADOR 4169



Distancia taladro

64-96-128 mm

Cromo mate

4169MCM

## TIRADOR 4219



Distancia taladro

96 - 128 mm

Cromo brillo

421996128CR

## TIRADOR 4220 Y POMO 4820

4220



4820



50x50 mm



50x50 mm

Distancia taladro

128 mm

32 mm

Niquel mate

4220128NM

482032NM

Oro viejo

4220128OV

482032OV

## TIRADOR 4453



Distancia taladro	Cromo brillo
96 mm	445396CR

## TIRADOR 4403



Distancia taladro	Inox
160 mm	4403160IN

Tiradores modernos

## TIRADOR 4411



Distancia taladro	Cromo mate
160 mm	4411160MCM

## TIRADOR 4413



Distancia taladro	Cromo mate
160 mm	4413MCM

# TIRADORES MODERNOS

## TIRADOR 4141



Distancia taladro

160 mm

Inox

4141160IN

## TIRADOR 4414



Distancia taladro

128 mm

Cromo mate

4414128MCM

## TIRADOR 4133



Distancia taladro

160 mm

Cromo mate

4133CM

## TIRADOR 4168



Distancia taladro

160 mm

Cromo satinado

4168160CS

# TIRADOR 4498

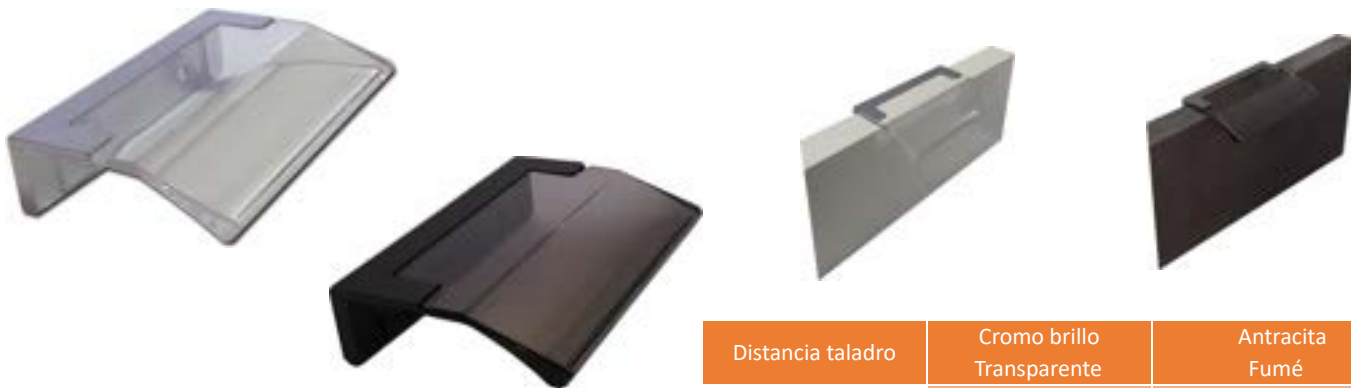

Distancia taladro	Cromo brillo Transparente	Antracita Fumé
32 mm	449832CRTR	449832GFFU
128 mm		4498128GFFU

Tiradores modernos

# TIRADOR 4477



Distancia taladros	Cromo brillo / Transparente
160 mm	4477160CR

# TIRADOR 4484



Distancia taladros	Cromo brillo / Transparente
160 mm	4484160CRCRT

# TIRADORES MODERNOS

## TIRADOR 4095



Distancia taladro

128 mm

Cromo mate

4095CM

## TIRADOR 4138



Distancia taladro

128 mm

Cromo mate

4138128CM

## TIRADOR 4137



Distancia taladro

128 mm

Cromo mate

4137128MCM

## TIRADOR 4106

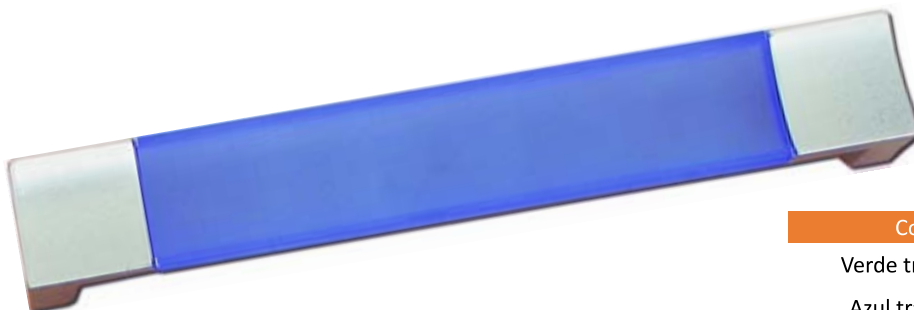

Color

Verde traslucido

Azul traslucido

Amarillo traslucido

128 mm

4106VET

4106AZT

4106AMT



# TIRADOR 4520



Tamaño	Cromo brillo	Cromo mate	Negro cobalto
150 mm	452015CR	452015CM	452015NGC
200 mm	452020CR	452020CM	452020NGC
250 mm	452025CR	452025CM	452025NGC
300 mm	452030CR	452030CM	452030NGC
350 mm	452035CR	452035CM	452035NGC
400 mm	452040CR	452040CM	452040NGC
450 mm	452045CR	452045CM	452045NGC
500 mm	452050CR	452050CM	452050NGC
600 mm	452060CR	452060CM	452060NGC
700 mm	452070CR	452070CM	452070NGC
800 mm	452080CR	452080CM	452080NGC
900 mm	452090CR	452090CM	452090NGC
1000 mm	4520100CR	4520100CM	4520100NGC

Tiradores modernos

Perfil tirador cantonera tipo trasero plata brillo.  
\*Consulta otras medidas.

# TIRADOR 4524

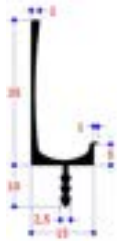

Perfil tirador cantonera para puerta recta.  
Consultar otros acabados.  
Longitud 3 metros.  
\* Consultar por medidas

Longitud	Plata mate	Negro	Inox	Blanco mate	Blanco brillo	Cobre
3 metros	45243000CM	45243000NG	45243000IN	45243000BL	45243000BLB	45243000COB

# TIRADORES CANTONERAS Y UÑEROS

## TIRADOR 4536

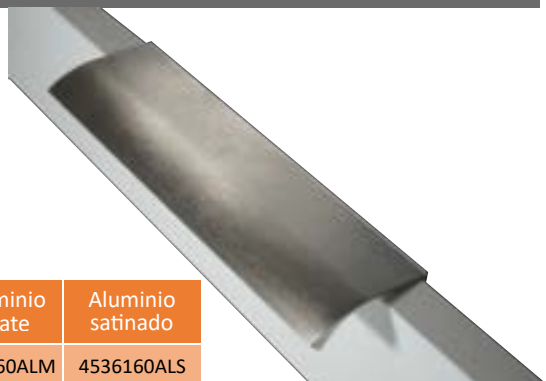

Distancia taladro	Aluminio mate	Aluminio satinado
160 mm	4536160ALM	4536160ALS

## TIRADOR 4539



Dist. taladro	Cromo mate	Cromo brillo
32 mm	453932CM	453932CR

## TIRADOR 4468



Perfil tirador trasero varios acabados en tiras de 3 metros o a medida de la puerta

Longitud	Cromo mate	Cromo brillo	Inox	Blanco	Negro
3 metros	44683000CM	44683000CR	44683000IN	44683000BL	44683000NG

## TIRADOR 4186



Distancia taladro	Cromo mate
64 mm	4186CM

## TIRADOR 4415



Medidas	Cromo mate
150 mm	4415CM

## TIRADOR 4546

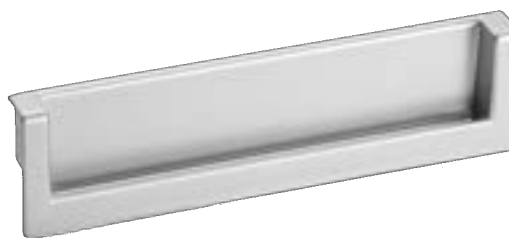

Medidas	Cromo mate
160 mm	4546160CM

## TIRADOR 4486



Perfil tirador trasero varios acabados en tiras de 3 metros o a medida de la puerta  
Medida aproximada de descuento 25 mm ( no nos hacemos responsables de variaciones de medidas de los fabricantes ).

Longitud	Cromo mate	Cromo brillo	Inox
3 metros	44863000CM	44863000CR	44863000IN

# TIRADOR 4428

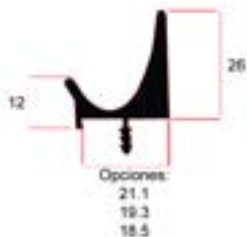

Perfil tirador cantonera para puerta recta o postformada en R-3. Grososres sujetos a disponibilidad, varios acabados. Longitud 3 metros



\* Las medidas pueden variar, consultar

Tiradores modernos

Grosor	Cromo mate	Cromo brillo
18 mm	442818CM	442818CR
19 mm	442819CM	442819CR
21 mm	442821CM	442821CR

# TIRADOR 4490

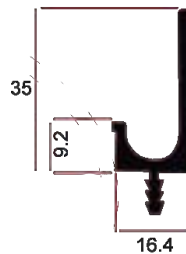

Perfil tirador cantonera para puerta recta, varios acabados. Longitud 3 metros

\* Las medidas pueden variar, consultar

Grosor	Cromo mate	Cromo brillo	Blanco
16 mm	4490CM	4490CR	4490BL

# TIRADOR 4491

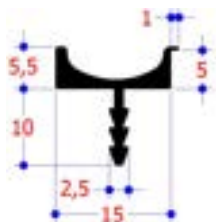

Perfil tirador cantonera para puerta recta, varios acabados. Longitud 3 metros.



\* Las medidas pueden variar, consultar

Grosor	Cromo mate	Cromo brillo
16 mm	4491CM	4491CR

# TIRADORES CANTONERAS Y UÑEROS

## TIRADOR 4487



Perfil tirador uñero para modulos altos varios acabados en tiras de 3 metros con goma anti-golpe para tablero de 16 mm y 19 mm

\* Las cotas pueden variar, la empresa no se hace responsable de los cortes de material según las mismas.  
\*\* Consultar otras medidas y acabados

Grosor	Blanco	Cromo mate	Inox
16 mm	4487300BL	4487300CM	4487300IN
19 mm	448730019BL	448730019CM	448730019IN

## PERFIL GOLA



Tiras de 4 metros  
\* Consultar otras medidas y acabados

	Cromo mate	Cromo brillo	Inox	Blanco	Negro		Cromo mate	Cromo brillo	Inox	Blanco	Negro
"U"	60GUAL	60GUCL	60GUIN	60GUBL	60GUNG	"J"	60GLAL	60GLCR	60GLIN	60GLBL	60GLNG
Tapas	60GTUAL	60GTUCL	60GTUIN	60GTUBL	60GTUNG	Tapas	60GTLAL	60GTLCR	60GTLIN	60GTLBL	60GTJNG
Esquina	60GUEAL			60GUEBL		Esquina	60GLEAL			60GLEBL	
Rincón	60GURAL			60GURBL		Rincón	60GLRAL			60GLRBL	
Angulo Amarre	60GAA					Vertical 2.35 M	60GVAL			60GVBL	

## TIRADOR 4498



Distancia taladro	Cromo brillo Transparente	Antracita Fumé
32 mm	449832CRTR	449832GFFU
128 mm		4498128GFFU

## TIRADOR 4276 POMO 4853 (CRISTAL SWAROVSKI)



4276



4853

Distancia taladro	Plata vieja
96 mm	427696PSW
16 mm (diámetro)	4853PVSW

Tiradores modernos

## TIRADOR 4273 POMO 4854 (CRISTAL SWAROVSKI)



4273



4854

Distancia taladro	Plata vieja
128 mm	4273128PVSW
25x20 mm	4854PVSW

## TIRADOR 4420 (CRISTAL STRASS)



Dist mm	Cristal Strass	Cromo brillo	Cromo mate	Inox.
128	4420128160CRST		4420128160	4420128160IN
160				
320	4420288320CRST	4420288320CR	4420288320CM	4420288320IN
288				

# TIRADORES BLACK&WHITE

## TIRADOR 4472



Distancia taladro

96-128 mm

Cromo blanco

447296128CR

## TIRADOR 4423



Distancia taladro

320 mm

Blanco

4423320CRBL

Negro

4423320CRNG

## TIRADOR 4422



Distancia taladro

192 mm

Cromo blanco

4422192CRBL

## TIRADOR 4421



Distancia taladro

192-224 mm

Blanco

4421192224CRBL

Negro

4421192224CRNG

## TIRADOR 4547



Distancia taladros	Negro
160 mm	4547160NG

## TIRADOR 4548



Distancia taladros	Negro
192 mm	4548192NG

## TIRADOR 4549



Distancia taladros	Negro
160 mm	4549160NG

## TIRADOR 4550



Distancia taladros	Negro
96 mm	455096NG

# TIRADORES BLACK&WHITE

## TIRADOR 4543



Distancia taladro	Cromo mate	Negro
192 mm	4543192CM	4543192NG

## TIRADOR 4541



Distancia taladros	Negro
160 mm	4541160NG
320 mm	4541320NG

## TIRADOR 4469



Distancia taladros	Cromo brillo	Blanco	Negro	Oro mate
128 mm	4469128CR	4469128BL	4469128NG	4469128ORM
224 mm		4469224BL	4469224NG	4469224ORM
320 mm	4469320CR			

## TIRADOR 4551 Y POMO 4874



4551128NG



4874NG

\* Consultar otros acabados

Distancia taladros	Negro
128 mm	4551128NG
25 x 25 mm	4874NG



## TIRADOR 4553

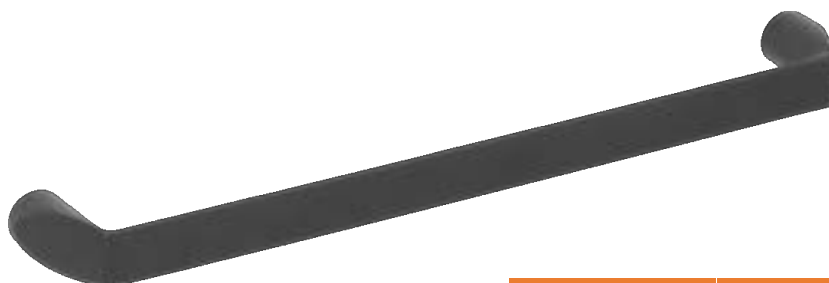

Distancia taladro	Cromo brillo	Inox	Negro
160 mm	4553160CR	4553160IN	4553160NG
224 mm	4553224CR	4553224IN	4553224NG

Tiradores modernos

## TIRADOR 4523



Distancia taladro	Cromo cobalto
160 mm	4523160NGC

## TIRADOR 4527



Distancia taladro	Inox	Negro
160 mm	4527160ININ	4527160INNG

# TIRADORES BLACK&WHITE

## TIRADOR 4135



Dist. taladro	Cromo mate	Inox	Blanco	Negro	Cobre mate	Oro mate
128 mm	4135128MCM					
160 mm		4135160IN	4135160BL	4135160NG	4135160COM	4135160ORM
256 mm	4135256CM	4135256IN	4135256BL			

## TIRADOR 4522



Dist.	Negro Cobalto
192 mm	4522192NGC

## TIRADOR 4532



Distancia taladros	Negro
192 mm	4532192NG

POMO 4873

POMO 4871

POMO 4124

POMO 4874

POMO 4872



Tamaño	Negro	Tamaño	Negro	Tamaño	Negro	Tamaño	Negro	Tamaño	Negro
30 x 30 mm	4873NG	Ø 30 mm	4871NG	30 x 30 mm	4124NG	25 x 25 mm	4874NG	Ø 35 mm	4872NG

# TIRADOR 4461M



Colección tiradores metacrilato modelo Minimal

COLORES	192 mm
NARANJA	4461192CRMNA
ROSA	4461192CRMRO
ROJO	4461192CRM RJ
PISTACHO	4461192CRMPI

# TIRADOR 4461

COLORES	160 mm	192 mm
BURDEOS	4461160CRBU	4461192CRBU
MARRÓN	4461160CRMA	4461192CRMA
MORADO	4461160CRM O	4461192CRM O
NEGRO	4461160CRNE	4461192CRNE
PISTACHO	4461160CRPI	4461192CRPI
NARANJA	4461160CRNA	4461192CRNA
ROJO	4461160CRRJ	4461192CRRJ
ROSA	4461160CRRO	4461192CRRO



Tiradores modernos

# POMOS 4857

Pomos series infantil



ACABADOS	REFERENCIA
BALÓN	4857BA
CARACOL	4857CA
COCHE	4857CO
ELEFANTE	4857E
GATO	4857G
PEZ	4857P
TIGRE	4857TI

# POMO 4123

Tirador moderno varios acabados con formas rectas.

Varias medidas

\* Consultar pedidos y cantidades.

COLOR	REFERENCIA
AMARILLO	4123AM
AZUL	4123AZ
BLANCO TRASLUCIDO	4123BL
VERDE ESMERALDA	4123ES
ROSA MAGENTA	4123MA



## COLECCIÓN MODERNA



Medidas	Inox
40x40 mm	4859IN

Pomo cuadrado embutido



Medidas	Cromo mate
40x40 mm	4858CM

Pomo redondo embutido



Medidas	Cromo mate	Inox	Negro
73x39 mm	4082MCM	4082IN	4082NG

Tirador rectangular embutido



Acabado	25x25 mm
Cromo brillo	4845CR

Pomo tirador diseño curvo



Acabado	23x15 mm
Cromo mate	4861CM
Inox	4861IN

Pomo curvo



Acabado	15x15 mm
Cromo mate	4843CM
Inox	4843IN

Pomo recto curvo



Acabado	13 mm
Inox	4862IN
Cromo mate	4862CM

Pomo acabado curvo



Acabado	16 mm
Cromo mate	4863CM
Inox	4863IN

Pomo recto



Acabado	44x44 mm
Cromo mate	4866CM
Inox	4866IN

Pomo cuadrado



Acabado	31 mm
Cromo mate	4126CM
Inox	4126IN
Negro	4123NG

Pomo redondo



Acabado	33x19 mm
Cromo mate	4842CM
Inox	4842IN

Pomo ovalado



Acabado	30x30 mm
Niquel mate	482032NM
Oro viejo	482032OV

Pomo cuadrado taladro 32mm



Medidas	Inox
Taladro 32 mm	418432IN
Taladro 64 mm	418464IN

Pomo cuadrado



Acabado	45x20 mm
Cromo mate	4864CM
Cromo brillo	4864CR
Inox	4864IN

Pomo rectangular



Acabado	32 mm
Cr. mate	442032CM
Cr. Brillo	442032CR
Inox	442032IN
Cr. Strass	442032CRST

Pomo rectangular



Acabado	13 mm
Cromo mate	4831CM

Pomo curvo



Acabado	37x7 mm
Cromo mate	4802MCM

Pomo curvo



Acabado	17x28 mm
Inox	4840IN

Pomo curvo



Acabado	14 mm
Cromo mate	4865CM

cilindrico con huella



Acabado	30x30 mm
Cromo mate	4124CM
Negro	4124NG



Diametro	Cromo mate
35 mm	103489X

Pomo acabado redondo



Acabado	25 x 25 mm
Negro	4874NG



Acabado	35mm Ø 22 mm I
Inox	4870IN

Pomos



Tirador comodilla plano	82x32 mm
Cromo mate	4443CM
Oro	4443OR
Oro viejo	4443OV
Negro	4443NG

Tirador Concha Niquel Viejo	
64 mm	455264NV
96 mm	455296NV



Acabado	90 mm
Cromo mate	4460CM

Pomo curvo (1 taladro)



\* Consultar acabados por encargo

Acabados	Plata vieja	Oro Viejo	Negro	Cromo brillo	Cromo mate	Cobre Viejo
64 mm	20121PV	20121BC	20121NG	20121CR	20121X	20121CV

# POMOS

## COLECCIÓN POMOS COLOR REDONDOS 4872



## COLECCIÓN POMOS COLOR CUADRADO 4873



Modelo	Antracita	Negro	Gris	Blanco	Oro viejo	Cobre
Redondo H-24 Ø 19	4872A	4872NG	4872CM	4872BL	4872OV	4872COV
Cuadrado H- 22 30x30	4873A	4873NG	4873CM	4873BL	4873OV	4873COV

## COLECCIÓN POMOS COLOR REDONDOS 4871



Dimensiones	Oro mate	Cromo mate	Negro	Blanco
Diametro 30mm	4871ORM	4871CM	4871NG	4871BL

## COLECCIÓN POMOS COLOR CUADRADO 4871 Y 4877



Cuadrado	Oro viejo	Plata Vieja	Negro	Cuadrado 28x28x28
Diametro 30mm	4811OV	4811PV	4811NG	4877OV

## COLECCIÓN POMOS COLOR OVALADOS 4876

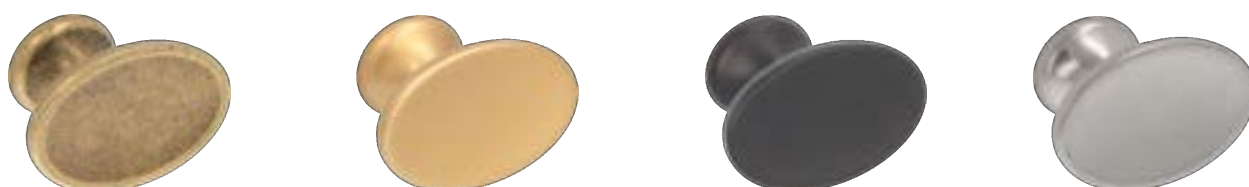

Dimensiones	Oro viejo	Oro mate	Negro	Niquel Viejo
H-27 42x28 mm	4876OV	4876ORM	4876NG	4876NV

## COLECCIÓN LUXE



\* Consultar condiciones y cantidades

Antracita	Gris	Blanco	Oro	Bronce
5001A	5001GR	5001BL	5001O	5001BC



\* Consultar condiciones y cantidades

Antracita	Gris	Blanco	Oro	Bronce
5000A	5000GR	5000BL	5000O	5000BC

## POMOS CLÁSICOS



Acabado	30 x 30 mm
Oro viejo flor marrón	486930OVFM

Pomo clásico



Acabado	90 mm
Oro viejo	4803OV
Plata vieja	4803PV

Pomo clásico



Acabado	45 x 26 mm
Oro viejo	4855OV
Plata vieja	4855PV

Pomo clásico



Acabado	25 x 20 mm
Plata vieja Swarovski	4854PVSW

Pomo clásico

Tiradores clásicos



Acabado	Diametro 16 mm
Plata vieja Swarovski	4853PVSW

Pomo clásico



Acabado	55 mm
---------	-------



Oro Flor roja	Oro Flor verde
4099BCRJ	4099BCVE

# POMOS



Acabado	35x35 mm
Plata blanco	4850PVBL

Pomo clásico



Acabado	35x35mm
Oro viejo	4818POV

Pomo clásico



Acabado	35x35 mm
Plata vieja	4832PV
Oro viejo	4832OV

Pomo clásico



Acabado	41 mm
Oro viejo	4834OV

Pomo clásico



Acabado	35x30 mm
Plata vieja	4852PV
Oro viejo	4852OV

Pomo clásico



Acabado	32 mm
Oro viejo	4828OV

Pomo clásico



Acabado	36 mm
Oro Viejo	4835OV

Pomo clásico



Acabado	30 mm
Oro Viejo	4849OV

Pomo clásico



Acabado	Ø 35 mm
Poliamida blanca	1010510



Pomo	Oro viejo Blanco crema
20 mm	486820OVCR



Pomo	Plata vieja Blanco liso
	486820PVBL



Pomo	Plata vieja Flor
	486820PVFG



Pomo	Flor marrón	Flor azul	Pera	Flor verde
Oro viejo			4804OVP	4804OVFV
Plata vieja	4804PVFM	4804PVAZ	4804PVP	



## TIRADOR 4288



Distancia taladro	Plata vieja	Oro viejo
96 mm	428896PV	428896OV

## TIRADOR 4290



Distancia taladro	Plata vieja
128 mm	4290128PV

## TIRADOR 4292



Distancia taladro	Oro viejo
128 mm	4292128OV

## TIRADOR 4291



Distancia taladro	Plata vieja	Oro viejo
128 mm	4291128PV	4291128OV

Tiradores clásicos

# TIRADOR CLÁSICO

## TIRADOR 4293



Distancia taladro

128 mm

Oro viejo

4293128OV

## TIRADOR 4554

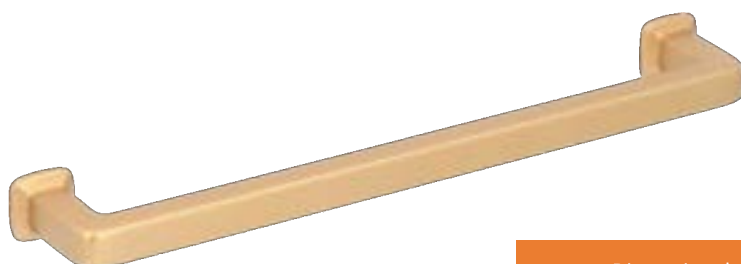

Distancia taladro

160 mm

Oro mate

4554160ORM

## TIRADOR 4259



Distancia taladro

96-128 mm

Plata vieja

4259128PV

Oro viejo

4259128OV

## TIRADOR 4255



Distancia taladro

96 mm

Plata vieja

425596PV

## TIRADOR 4254



Distancia taladro	Oro viejo
96 mm	425496OV

## TIRADOR 4257



Distancia taladro	Oro viejo
96 mm	425796OV

## TIRADOR 4225



Distancia taladro	Oro viejo
96 mm	422596OV

# TIRADOR CLÁSICO

## TIRADOR 4262



Distancia taladro

96-128 mm

Oro viejo

426296128OV

## TIRADOR 4247 POMO 4828



Distancia taladro

96 mm

32 mm

Plata vieja

424796PV

4828PV

Oro viejo

424796OV

4828OV

## TIRADOR 4258



Distancia taladro

96 mm

Plata vieja

425896PV

## TIRADOR 4270



Distancia taladro

96 mm

Plata vieja

427096PV

Oro viejo

427096OV

## TIRADOR 4271



Distancia taladro	Plata vieja	Oro viejo
96 mm	427196PV	427196OV

## TIRADOR 4275 POMO 4855



Distancia taladro	Plata vieja	Oro viejo
96 mm	427596PV	427596OV
Pomo	4855PV	4855OV

## TIRADOR 4249



Distancia taladro	Plata vieja	Oro viejo
96 mm	424996PV	424996OV

## TIRADOR 4240



Distancia taladro	Plata vieja
96 mm	424096PV

# TIRADOR CLÁSICO

## TIRADOR 4243



Distancia taladro	Oro viejo
96 mm	424396OV

## TIRADOR 4248



Distancia taladro	Plata vieja	Oro viejo
96 mm	424896PV	424896OV

## TIRADOR 4245 POMO 4834



Distancia taladro	Plata vieja	Oro viejo
96 mm	424596PV	424596OV
Ancho 41 mm	* Consultar	4834OV

## TIRADOR 4246



Distancia taladro	Plata vieja	Oro viejo
96 mm	424696PV	424696OV

## TIRADOR 4220



Distancia taladro	Niquel mate	Oro viejo
128 mm	4220128NM	4220128OV
32x32 mm	482032NM	482032OV

## TIRADOR 4215



Distancia taladro	Oro viejo
96 mm	4215OV

## TIRADOR 4211



Distancia taladro	Plata vieja	Oro viejo
96 mm	4211PV	4211OV

## TIRADOR 4213



Distancia taladro	Forja negro
96 mm	4213F

Tiradores clásicos

# TIRADOR CLÁSICO

## TIRADOR 4252



Distancia taladro

96 mm

Oro viejo

425296OV

## TIRADOR 4231



Distancia taladro

96 mm

Oro viejo

4231OV

## TIRADOR 4075



Distancia taladro

128 mm

Forja plata

209/1320PV

## TIRADOR 4170



Distancia taladro

128 mm

Niquel viejo

4170128NV

Lacado Oro viejo

4170128OV



## TIRADOR 4289



Distancia taladro	Oro viejo
160 mm	4289160OV

## TIRADOR 4278



Distancia taladro	Oro viejo
128 mm	4278128OV

## TIRADOR 4279



Distancia taladro	Oro viejo
128 mm	4279128OV

## TIRADOR 4282



Distancia taladro	Oro viejo
128 mm	4282128OV

# TIRADOR CLÁSICO

## TIRADOR 4238 POMO 4832



Distancia taladro	Plata vieja	Oro viejo
96 mm		423896OV
35x35 mm	4832PV	4832OV

## TIRADOR 4000



Distancia taladro	Oro viejo
96 mm	20350ABC

## TIRADOR 4037 - 20148



Distancia taladro	Oro viejo
96 mm	20148BC

## TIRADOR 4256



Distancia taladro	Plata vieja	Oro viejo
96 mm	425696PV	425696OV

## TIRADOR 4264



Distancia taladro

96 mm

Plata vieja

426496PV

## TIRADOR 4263



Distancia taladro

96 mm

Oro viejo

426396OV

## TIRADOR 4261 POMO 4850

4261



4850



Distancia taladro

96 – 128 mm

Pomo 35x35 mm

Plata vieja – blanco

426196128PV

4850PVBL

## TIRADOR 4287



Acabado

Oro viejo crema  
Plata vieja blanco liso  
Oro viejo trama azul  
Plata vieja trama azul

128 mm

4287128OVCR  
4287128PVBL  
4287128OVTR  
4287128PVTR

160 mm

4287160OVCR  
4287160PVBL

# TIRADOR CLÁSICO

## TIRADOR 4286 POMO

4286



4869

Distancia taladro

Oro viejo flor marrón

96 mm

428696OVFM

30x30 mm

486930OVFM

## TIRADOR 4217



Distancia taladro

Oro viejo mosaico

96 - 128 mm

4217OVM

## TIRADOR 4218 POMO 4818



4218BC



4818POV

Distancia taladro

Oro viejo

96 - 128 mm

4218BC

Pomo 35x35

4818POV

## TIRADOR 4284



Acabado

128 mm

Oro viejo espiga

4284128OVE

## TIRADOR 4283 POMO 4868



Distancia taladro	Plata vieja flor gris	Oro viejo flor marrón	Oro viejo flor gris	Oro viejo blanco crema
128 mm	4283128PVFG	4283128OVFM	4283128OVFG	
Pomo 20 mm	486820PVFG			486820OVCR

## TIRADOR 4285 POMO 4868



Acabado	128 mm	Pomo 20 mm
Plata vieja flor azul	4285128PVFA	
Plata vieja blanco liso	4285128PVBL	486820PVBL

## TIRADOR 4090 POMO 4868



Acabado	128 mm	Pomo 20
Plata vieja blanco liso	4090128PVBL	486820PVBL
Oro viejo crema	4090128OVCR	486820OVCR

## TIRADOR 4200 POMOS 4800 Y 4801



Acabado	96 mm	Pomo 35 mm	Pomo 60x30
Oro viejo espiga	4200OVE	4800OVE	4801OVE

Tiradores clásicos

# TIRADOR CLÁSICO

## TIRADOR 4132



Distancia taladro

96 mm

Oro viejo girasol

4132OV

## TIRADOR 4277



Distancia taladro

96 mm

Oro viejo Blanco

427796OVBL

## TIRADOR 4236



Distancia taladro

96 mm

Oro viejo Blanco

423696OVBL

Oro viejo Craquelé

423696OVCR



## TIRADOR 4204

4204



4803



Distancia taladro

128 mm

Ancho 90 mm

Plata vieja

4204128PV

4803OV

Oro viejo

4204128OV

4803PV

## TIRADOR 4088 POMO 4099



Acabado	96 mm	Pomo 55 mm
Oro viejo flor marrón	4088BCMA	* Consultar
Oro viejo flor roja	* Consultar	4099BCRJ
Oro viejo flor verde	* Consultar	4099BCVE

## TIRADOR 4205



96 mm	Flor marrón	Flor azul	Pera	Flor verde
Oro viejo	4205OVFM	* Consultar	4205OVP	* Consultar
Plata vieja	4205PVFM	4205PVAZ	4205PVP	4205PVFV

## TIRADOR 4206



128 mm	Flor azul	Pera	Flor verde
Oro viejo	4206OVAZ	4206OVP	4206OVFV
Plata vieja	4206PVAZ	4206PVP	4206PVFV

## POMO 4804



Pomo	Flor marrón	Flor azul	Pera	Flor verde
Oro viejo	4804OVFM	4804OVAZ	4804OVP	4804OVFV
Plata vieja	4804PVFM	4804PVAZ	4804PVP	4804PVFV

# ÍNDICE REFERENCIAL ASAS Y POMOS

Ref.	Página	Ref.	Página	Ref.	Página	Ref.	Página	Ref.	Página	Ref.	Página
4025	135	4231	174	4418	136	4493	131	4546	119	4864	143
4037	139	4236	180	4419	136	4496	127	4546	152	4864	162
4080	125	4238	176	4420	133	4497	127	4547	157	4865	163
4082	162	4240	171	4420	155	4498	149	4548	157	4866	162
4088	181	4243	172	4420	162	4498	154	4549	157	4868	166
4090	179	4245	172	4421	156	4500	136	4550	157	4868	179
4095	150	4246	172	4422	156	4501	145	4551	158	4869	165
4099	165	4247	170	4423	156	4503	135	4552	163	4870	163
4106	150	4248	172	4428	153	4504	135	4553	138	4871	160
4107	144	4249	171	4429	125	4505	135	4554	168	4871	164
4122	142	4252	174	4430	140	4506	129	4800	179	4872	160
4123	161	4254	169	4432	141	4507	130	4801	179	4872	164
4124	160	4255	168	4433	132	4508	128	4802	163	4873	160
4124	163	4256	176	4434	128	4509	134	4803	165	4874	160
4126	162	4257	169	4435	143	4510	131	4803	180	4874	163
4132	180	4258	170	4437	134	4511	129	4804	166	4876	164
4133	148	4259	168	4439	128	4512	132	4804	166	4877	164
4135	137	4261	177	4440	139	4513	130	4804	181	5000	120
4135	160	4262	170	4443	163	4515	130	4811	164	5000	165
4136	142	4263	177	4445	130	4517	129	4818	166	5001	120
4137	150	4264	177	4449	124	4518	129	4818	178	5001	165
4138	150	4270	170	4450	126	4519	128	4820	146	5002	121
4140	139	4271	171	4452	131	4520	151	4820	162	5003	120
4141	148	4273	155	4453	147	4522	127	4820	173	5004	120
4152	144	4275	171	4459	140	4522	160	4828	166	5005	121
4155	138	4276	155	4460	163	4523	159	4828	166	5006	121
4161	144	4277	180	4461	161	4524	151	4828	170	5007	121
4165	144	4278	175	4461	161	4525	122	4831	163	5008	122
4168	148	4279	175	4462	126	4526	142	4832	166	20121	163
4169	146	4282	175	4463	126	4527	122	4832	176	1010510	166
4170	174	4283	179	4464	133	4527	159	4834	166	103489X	163
4172	132	4284	178	4465	136	4528	122	4834	172	20148BC	176
4184	143	4285	179	4466	133	4529	123	4835	166	20350ABC	176
4184	162	4286	178	4467	142	4530	123	4840	163	209/1320	174
4185	143	4287	177	4468	152	4531	123	4842	162	60GL	154
4186	152	4288	167	4469	137	4532	160	4843	162	60GTJ	154
4188	124	4289	175	4471	131	4533	127	4845	162	60GTL	154
4190	124	4290	167	4472	156	4534	126	4849	166	60GTU	154
4194	141	4291	167	4473	138	4534	159	4850	166	60GU	154
4200	179	4292	167	4477	149	4535	123	4850	177	60GV	154
4204	180	4293	168	4478	145	4536	152	4852	166		
4205	181	4402	146	4479	145	4537	118	4853	155		
4206	181	4403	147	4480	133	4539	119	4853	165		
4211	173	4407	134	4481	140	4539	152	4854	155		
4213	173	4408	141	4483	145	4540	118	4854	165		
4215	173	4409	141	4484	149	4541	158	4855	165		
4217	178	4410	134	4486	152	4541	158	4857	161		
4218	178	4411	147	4487	154	4542	118	4858	162		
4219	146	4412	143	4489	124	4543	118	4859	162		
4220	146	4413	147	4490	153	4543	158	4861	162		
4220	173	4414	148	4491	153	4544	119	4862	162		
4225	169	4415	152	4493	131	4545	119	4863	162		

## NOMENCLATURA

A Antracita  
 AL Aluminio  
 ALCR Aluminio, Cromo brillo  
 BC Bronce  
 BL Blanco  
 CE Cerezo  
 CM Cromo mate  
 CMCR Cromo mate, cromo brillo  
 CR Cromo brillo  
 CV Cobre viejo

F Forja  
 GR Gris  
 HY Haya  
 INCR Inox, cromo brillo  
 INOX Inoxidable  
 L Liso  
 MA Marrón  
 MCM Metalizado cromo mate  
 N Negro  
 NM Niquel mate

O Oro  
 OV Oro Viejo  
 P Puntos  
 PI Pino  
 PM Plata mate  
 PV Plata vieja  
 RB Roble  
 SP Sapelly  
 TR Transparente